

# COLLETTORI

## *Manifolds*

### **CARATTERISTICHE TECNICO/COSTRUTTIVE GENERALI**

- **Materiali**
  - Stampato: ottone UNI EN 12165-CW617N
  - Fuso: UNI EN 1982/2008
  - Barra: ottone UNI EN 12168-CW614N
- Finitura: nichelata o gialla
- Tipi di filettature: ISO 228
- Interassi mm 36 o 50
- Pressione massima: 10bar
- Durante le lavorazioni tutti i particolari sono controllati secondo modalità definite nelle procedure del sistema qualità aziendale, certificato secondo la norma UNI EN ISO 9001:2008

Le caratteristiche e le misure sono indicative e non impegnano la BIANCHI F.LLI, che si riserva il diritto di apportare ai propri articoli, in qualunque momento e senza preavviso, modifiche tecniche o commerciali.



**BIANCHI F.LLI S.p.a.**  
Rubinetteria

---

MADE IN ITALY  
[www.bianchifratelli.it](http://www.bianchifratelli.it)



Collettore a 2 attacchi  
filetto maschio  
*Manifold with 2 male offtakes*  
*Colector de 2 empalmes  
rosca macho*

**202**

Code	Version	Size (D)	Smooth	€	D1	H	I	L	Pack
2020050400		3/4	●	<b>5,05</b>	-	-	36	85	8
2020C50400		3/4	●	<b>5,40</b>	-	-	36	85	8
2020060400		1"	●	<b>6,61</b>	-	-	36	85	8
2020C60400		1"	●	<b>7,01</b>	-	-	36	85	8

**Sede piana - Flat seat**

2020050460		3/4	●	<b>5,05</b>	-	-	36	85	8
2020C50460		3/4	●	<b>5,40</b>	-	-	36	85	8
2020060460		1"	●	<b>6,61</b>	-	-	36	85	8
2020C60460		1"	●	<b>7,01</b>	-	-	36	85	8

**202X connection 24x19**

202X050000		3/4	●	<b>5,34</b>	24x19	-	36	85	8
202X060000		1"	●	<b>6,96</b>	24x19	-	36	85	8

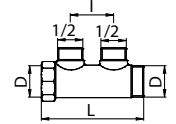

Collettore a 3 attacchi  
filetto maschio  
*Manifold with 3 male offtakes*  
*Colector de 3 empalmes  
rosca macho*

**203**

Code	Version	Size (D)	Smooth	€	D1	H	I	L	Pack
2030050400		3/4	●	<b>7,05</b>	-	-	36	121	8
2030C50400		3/4	●	<b>7,47</b>	-	-	36	121	8
2030060400		1"	●	<b>9,00</b>	-	-	36	121	6
2030C60400		1"	●	<b>9,61</b>	-	-	36	121	6

**Sede piana - Flat seat**

2030050460		3/4	●	<b>7,05</b>	-	-	36	121	8
2030C50460		3/4	●	<b>7,47</b>	-	-	36	121	8
2030060460		1"	●	<b>9,00</b>	-	-	36	121	6
2030C60460		1"	●	<b>9,61</b>	-	-	36	121	6

**203X connection 24x19**

203X050000		3/4	●	<b>7,68</b>	24x19	-	36	121	8
203X060000		1"	●	<b>9,48</b>	24x19	-	36	121	6

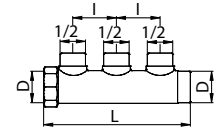

Collettore a 4 attacchi  
filetto maschio  
*Manifold with 4 male offtakes*  
*Colector de 4 empalmes  
rosca macho*

**204**

Code	Version	Size (D)	Smooth	€	D1	H	I	L	Pack
2040050400		3/4	●	<b>9,03</b>	-	-	36	157	8
2040C50400		3/4	●	<b>9,50</b>	-	-	36	157	8
2040060400		1"	●	<b>11,72</b>	-	-	36	157	6
2040C60400		1"	●	<b>12,19</b>	-	-	36	157	6

**Sede piana - Flat seat**

2040050460		3/4	●	<b>9,03</b>	-	-	36	157	8
2040C50460		3/4	●	<b>9,50</b>	-	-	36	157	8
2040060460		1"	●	<b>11,72</b>	-	-	36	157	6
2040C60460		1"	●	<b>12,19</b>	-	-	36	157	6

**204X connection 24x19**

204X050000		3/4	●	<b>9,07</b>	24x19	-	36	157	8
204X060000		1"	●	<b>11,96</b>	24x19	-	36	157	6

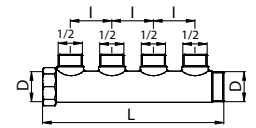



Collettore a 5 attacchi filetto maschio  
*Manifold with 5 male offtakes*  
Colector de 5 empalmes rosca macho

### 205

Code	Version	Size (D)	Smooth	€	D1	H	I	L	Pack
2050050400		3/4	●	<b>12,19</b>	-	-	36	193	8
2050C50400		3/4	●	<b>12,77</b>	-	-	36	193	8
2050060400		1"	●	<b>14,67</b>	-	-	36	193	6
2050C60400		1"	●	<b>15,54</b>	-	-	36	193	6

#### Sede piana - Flat seat

2050050460		3/4	●	<b>12,19</b>	-	-	36	193	8
2050C50460		3/4	●	<b>12,77</b>	-	-	36	193	8
2050060460		1"	●	<b>14,67</b>	-	-	36	193	6
2050C60460		1"	●	<b>15,54</b>	-	-	36	193	6

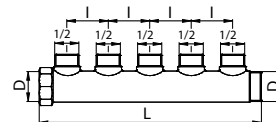

Collettore a 2 attacchi filetto femmina  
*Manifold with 2 female offtakes*  
Colector de 2 empalmes rosca hembra

### 222

Code	Version	Size (D)	Smooth	€	D1	H	I	L	Pack
2220050400		3/4	●	<b>5,07</b>	-	-	36	85	8
2220C50400		3/4	●	<b>5,37</b>	-	-	36	85	8
2220060400		1"	●	<b>6,61</b>	-	-	36	85	8
2220C60400		1"	●	<b>7,01</b>	-	-	36	85	8

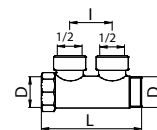

Collettore a 3 attacchi filetto femmina  
*Manifold with 3 female offtakes*  
Colector de 3 empalmes rosca hembra

### 223

Code	Version	Size (D)	Smooth	€	D1	H	I	L	Pack
2230050400		3/4	●	<b>7,53</b>	-	-	36	121	8
2230C50400		3/4	●	<b>7,99</b>	-	-	36	121	8
2230060400		1"	●	<b>9,01</b>	-	-	36	121	6
2230C60400		1"	●	<b>9,56</b>	-	-	36	121	6

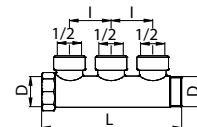

Collettore a 4 attacchi filetto femmina  
*Manifold with 4 female offtakes*  
Colector de 4 empalmes rosca hembra

### 224

Code	Version	Size (D)	Smooth	€	D1	H	I	L	Pack
2240050400		3/4	●	<b>9,80</b>	-	-	36	157	8
2240C50400		3/4	●	<b>10,39</b>	-	-	36	157	8
2240060400		1"	●	<b>11,72</b>	-	-	36	157	6
2240C60400		1"	●	<b>12,43</b>	-	-	36	157	6

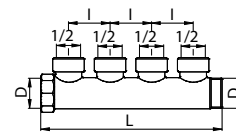

Collettore a 5 attacchi filetto femmina  
*Manifold with 5 female offtakes*  
Colector de 5 empalmes rosca hembra

### 225

Code	Version	Size (D)	Smooth	€	D1	H	I	L	Pack
2250050400		3/4	●	<b>12,48</b>	-	-	36	193	8
2250C50400		3/4	●	<b>13,04</b>	-	-	36	193	8
2250060400		1"	●	<b>15,35</b>	-	-	36	193	6
2250C60400		1"	●	<b>15,99</b>	-	-	36	193	6

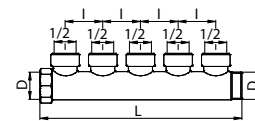



Collettore a 2 attacchi filetto maschio 1/2", interasse 50mm  
*Manifold with 2 male offtakes 1/2", interaxis 50mm*  
*Colector de 2 empalmes rosca macho 1/2", distancia entre ejes 50mm*

**202A**

Code	Version	Size (D)	Smooth	€	D1	H	I	L	Pack
202A050400		3/4	●	<b>6,40</b>	-	-	50	108	8
202AC50400		3/4	●	<b>6,85</b>	-	-	50	108	8

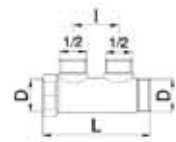

Collettore a 3 attacchi filetto maschio 1/2", interasse 50mm  
*Manifold with 3 male offtakes 1/2", interaxis 50mm*  
*Colector de 3 empalmes rosca macho 1/2", distancia entre ejes 50mm*

**203A**

Code	Version	Size (D)	Smooth	€	D1	H	I	L	Pack
203A050400		3/4	●	<b>9,10</b>	-	-	50	158	8
203AC50400		3/4	●	<b>9,73</b>	-	-	50	158	8

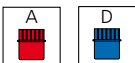
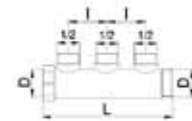

Collettore a 2 attacchi filetto maschio con valvola inclinata  
*Manifold with 2 male offtakes and oblique valve*  
*Colector de 2 empalmes con válvula inclinada*

**202B**

Code	Version	Size (D)	Smooth	€	D1	H	I	L	Pack
202B05040_	A/D	3/4	●	<b>11,85</b>	-	-	36	84	5
<b>Sede piana - Flat seat</b>									
202B05046_	A/D	3/4	●	<b>11,85</b>	-	-	36	84	5

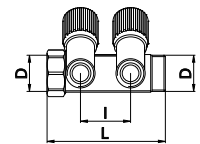

Collettore a 3 attacchi filetto maschio con valvola inclinata  
*Manifold with 3 male offtakes and oblique valve*  
*Colector de 3 empalmes con válvula inclinada*

**203B**

Code	Version	Size (D)	Smooth	€	D1	H	I	L	Pack
203B05040_	A/D	3/4	●	<b>16,63</b>	-	-	36	120	5
<b>Sede piana - Flat seat</b>									
203B05046_	A/D	3/4	●	<b>16,63</b>	-	-	36	120	5

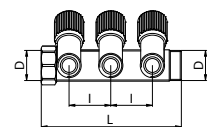



Collettore a 4 attacchi filetto maschio 1/2" con valvola inclinata

*Manifold with 4 male offtakes 1/2", and oblique valve*

*Colector de 4 empalmes con válvula inclinada*

### 204B

Code	Version	Size (D)	Smooth	€	D1	H	I	L	Pack
204B05040_	A/D	3/4	●	<b>22,35</b>	-	-	36	156	5

#### Sede piana - Flat seat

204B05046_	A/D	3/4	●	<b>22,35</b>	-	-	36	156	5
------------	-----	-----	---	--------------	---	---	----	-----	---

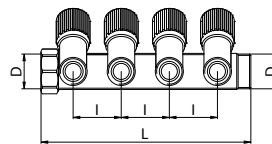

Collettore a 2 attacchi in **ADZ** interasse 50mm, attacco Eurocono

*2 ways **ADZ** brass Euroconus manifold, interaxis 50mm*

*Colector **ADZ** de 2 empalmes Eurocono distancia entre ejes 50mm*

### 202F **ADZ brass**

Code	Version	Size (D)	Smooth	€	D1	H	I	L	Pack
202F0505A_	A/D	3/4	●	<b>14,88</b>	3/4	-	50	107	5

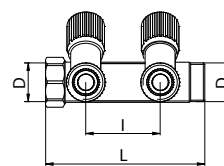

Collettore a 3 attacchi in **ADZ** interasse 50mm, attacco Eurocono

*3 ways **ADZ** brass Euroconus manifold, interaxis 50mm*

*Colector **ADZ** de 3 empalmes Eurocono distancia entre ejes 50mm*

### 203F **ADZ brass**

Code	Version	Size (D)	Smooth	€	D1	H	I	L	Pack
203F0505A_	A/D	3/4	●	<b>22,01</b>	3/4	-	50	157	5

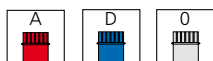
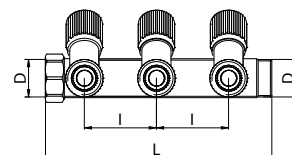

Collettore 2 attacchi **24x19** int. 42 mm con valvola inclinata

*Manifold with 2 male offtakes **24x19** and oblique valve, interaxis 42mm.*

*Colector **M** empalmes **24x19** distancia entre eyes 42 mm. con valvula inclinada*

### 202FX **connection 24x19**

Code	Version	Size (D)	Smooth	€	D1	H	I	L	Pack
202FX6000_	A/D/O	1"	●	<b>14,87</b>	24x19	-	42	92	5

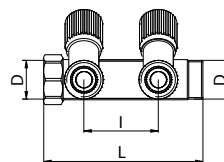

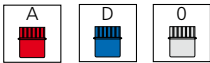

Collettore 3 attacchi **24x19** int. 42 mm con valvola inclinata  
*Manifold with 3 male offtakes 24x19 and oblique valve, interaxis 42mm.*  
*Colector M empalmes 24x19 distancia entre eyes 42 mm. con valvula inclinada*

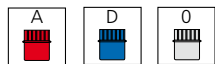

Collettore 4 attacchi **24x19** int. 42 mm con valvola inclinata  
*Manifold with 4 male offtakes 24x19 and oblique valve, interaxis 42mm.*  
*Colector M empalmes 24x19 distancia entre eyes 42 mm. con valvula inclinada*

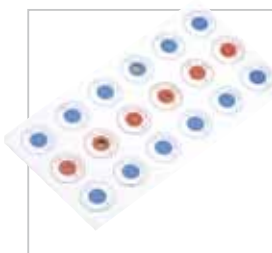

Etichette adesive per collettori con valvola inclinata  
*Labels for manifold with oblique valves*  
*Etiqueta para colector con válvula inclinada*



Collettore in **ADZ** a 2 attacchi filetto maschio 3/4" Eurocono  
*Manifold with 2 male offtakes 3/4" Euroconus ADZ brass*  
*Colector de ADZ 2 empalmes 3/4" Eurocono*



Collettore in **ADZ** a 3 attacchi filetto maschio 3/4" Eurocono  
*Manifold with 3 male offtakes 3/4" Euroconus ADZ brass*  
*Colector de ADZ 3 empalmes 3/4" Eurocono*

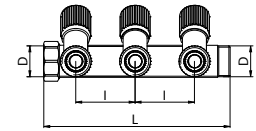

**203FX connection 24x19**

Code	Version	Size (D)	Smooth	€	D1	H	I	L	Pack
203FX6000_	A/D/O	1"	●	<b>21,69</b>	24x19	-	42	132	5

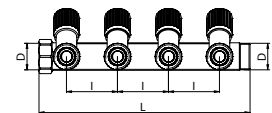

**204FX connection 24x19**

Code	Version	Size (D)	Smooth	€	D1	H	I	L	Pack
204FX6000_	A/D/O	1"	●	<b>34,41</b>	24x19	-	42	172	4

**315**

Code	Version	Size (D)	Smooth	€	D1	H	I	L	Pack
3150000000	-	-	-	<b>2,04</b>	-	-	-	-	1

Prezzo per etichetta

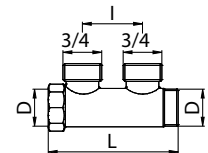

**202E ADZ brass**

Code	Version	Size (D)	Smooth	€	D1	H	I	L	Pack
202E05050A		3/4	●	<b>7,58</b>	-	-	50	108	8
202EC5050A		3/4	●	<b>8,03</b>	-	-	50	108	8
202E06050A		1"	●	<b>9,14</b>	-	-	50	109	8
202EC6050A		1"	●	<b>9,72</b>	-	-	50	109	8

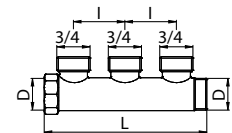

**203E ADZ brass**

Code	Version	Size (D)	Smooth	€	D1	H	I	L	Pack
203E05050A		3/4	●	<b>10,81</b>	-	-	50	158	8
203EC5050A		3/4	●	<b>11,48</b>	-	-	50	158	8
203E06050A		1"	●	<b>14,03</b>	-	-	50	159	6
203EC6050A		1"	●	<b>14,86</b>	-	-	50	159	6

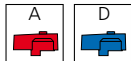

Collettore a 2 attacchi  
Eurocono con valvola a sfera  
incorporata

*2 ways manifold Euroconus  
with incorporated ball valve*

*Colector de 3 empalmes  
Eurocono con válvulas de bola  
incorporas*

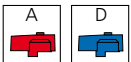

Collettore a 3 attacchi  
Eurocono con valvola a sfera  
incorporata

*3 ways manifold Euroconus  
with incorporated ball valve*

*Colector de 3 empalmes  
Eurocono con válvulas de bola  
incorporas*

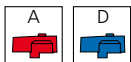

Collettore a 4 attacchi  
Eurocono con valvola a sfera  
incorporata

*4 ways manifold Euroconus  
with incorporated ball valve*

*Colector de 4 empalmes  
Eurocono con válvulas de bola  
incorporas*



Dado con bicono in P.T.F.E.

*Brass nut and P.T.F.E. ring*

*Tuerca con bicono de P.T.F.E.*

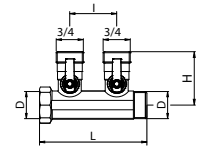

### 202C

Code	Version	Size (D)	Smooth	€	D1	H	I	L	Pack
202C05050_	A/D	3/4	●	<b>15,19</b>	-	55	45	103	5
202C06050_	A/D	1"	●	<b>16,87</b>	-	55	45	103	5

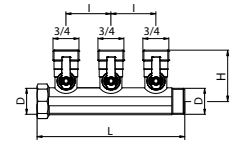

### 203C

Code	Version	Size (D)	Smooth	€	D1	H	I	L	Pack
203C05050_	A/D	3/4	●	<b>21,23</b>	-	55	45	148	5
203C06050_	A/D	1"	●	<b>24,47</b>	-	55	45	148	5

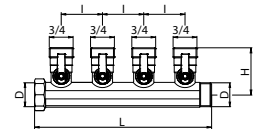

### 204C

Code	Version	Size (D)	Smooth	€	D1	H	I	L	Pack
204C05050_	A/D	3/4	●	<b>26,51</b>	-	55	45	193	4
204C06050_	A/D	1"	●	<b>29,06</b>	-	55	45	193	4

### 210÷216

Code	Version	Size (D)	Smooth	€	D1	H	I	L	Pack
210004200T		1/2x10	●	<b>1,21</b>	-	-	-	-	50
2100N4200T		1/2x10	●	<b>1,25</b>	-	-	-	-	50
212004220T		1/2x12	●	<b>1,21</b>	-	-	-	-	50
2120N4220T		1/2x12	●	<b>1,25</b>	-	-	-	-	50
214004240T		1/2x14	●	<b>1,21</b>	-	-	-	-	50
2140N4240T		1/2x14	●	<b>1,25</b>	-	-	-	-	50
215004250T		1/2x15	●	<b>1,21</b>	-	-	-	-	50
2150N4250T		1/2x15	●	<b>1,25</b>	-	-	-	-	50
216004260T		1/2x16	●	<b>1,21</b>	-	-	-	-	50
2160N4260T		1/2x16	●	<b>1,25</b>	-	-	-	-	50



Dado da 1/2 con bicono in gomma  
*Brass nut 1/2 and rubber ring*  
Tuerca 1/2 con bicono de goma

### 210G÷216G

Code	Version	Size (D)	Smooth	€	D1	H	I	L	Pack
210G04200G		1/2x10	●	<b>1,25</b>	-	-	-	-	50
210GN4200G		1/2x10	●	<b>1,29</b>	-	-	-	-	50
212G04220G		1/2x12	●	<b>1,25</b>	-	-	-	-	50
212GN4220G		1/2x12	●	<b>1,29</b>	-	-	-	-	50
214G04240G		1/2x14	●	<b>1,25</b>	-	-	-	-	50
214GN4240G		1/2x14	●	<b>1,29</b>	-	-	-	-	50
215G04250G		1/2x15	●	<b>1,25</b>	-	-	-	-	50
215GN4250G		1/2x15	●	<b>1,29</b>	-	-	-	-	50
216GN4260G		1/2x16	●	<b>2,06</b>	-	-	-	-	50



Dado con bicono in gomma,  
Eurocono  
*Euroconus brass nut and rubber ring*  
Tuerca con bicono de goma  
Eurocono

### 210E÷218E

Code	Version	Size (D)	Smooth	€	D1	H	I	L	Pack
210EC5200G		3/4x10	●	<b>2,98</b>	-	-	-	-	25
212EC5220G		3/4x12	●	<b>2,98</b>	-	-	-	-	25
214EC5240G		3/4x14	●	<b>2,98</b>	-	-	-	-	25
215EC5250G		3/4x15	●	<b>2,98</b>	-	-	-	-	25
216EC5260G		3/4x16	●	<b>2,98</b>	-	-	-	-	25
218EC5280G		3/4x18	●	<b>2,98</b>	-	-	-	-	25



Dado con bicono in gomma  
**24x19**  
*24x19 brass nut and rubber ring*  
Tuerca con bicono de goma  
**24x19**

### 214X÷218X connection 24x19

Code	Version	Size (D)	Smooth	€	D1	H	I	L	Pack
214XN02400		14	●	<b>2,52</b>	24x19	-	-	-	50
215XN02500		15	●	<b>2,52</b>	24x19	-	-	-	50
216XN02600		16	●	<b>2,52</b>	24x19	-	-	-	50
218XN02800		18	●	<b>2,52</b>	24x19	-	-	-	50



Adattatore per tubo  
multistrato  
*Multilayer tube adaptor*  
Adaptador para tubo  
multicapa

### 219

Code	Version	Size (D)	Smooth	€	D1	H	I	L	Pack
2190000408		1/2x14X2	●	<b>1,80</b>	-	-	-	-	50
219000040B		1/2x16X1,8	●	<b>1,80</b>	-	-	-	-	50
2190000403		1/2x16X2	●	<b>1,80</b>	-	-	-	-	50
2190000405		1/2x16X2,25	●	<b>1,80</b>	-	-	-	-	50
2190N00408		1/2x14X2	●	<b>1,85</b>	-	-	-	-	50
2190N0040B		1/2x16X1,8	●	<b>1,85</b>	-	-	-	-	50
2190N00403		1/2x16X2	●	<b>1,85</b>	-	-	-	-	50
2190N00405		1/2x16X2,25	●	<b>1,85</b>	-	-	-	-	50





Adattatore per tubo multistrato, in **ADZ**  
*Multilayer tube adaptor, ADZ brass*  
*Adaptator para tubo multicapa, de ADZ*



Adattatore per tubo plastica, in **ADZ**  
*Plastic tube adaptor, ADZ brass*  
*Adaptator para tubo de plastico, de ADZ*



Adattatore per tubo multistrato tipo Eurocono  
*Multilayer tube adaptor Euroconus type*  
*Adaptador para tubo multicapa tipo Eurocono*



Adattatore per tubo multistrato **24x19**  
*Multilayer 24x19 tube adaptor*  
*Adaptador 24x19 para tubo multicapa*

### 219A ADZ brass

Code	Version	Size (D)	Smooth	€	D1	H	L	M	Pack
21900004A3		1/2x16x2	●	<b>2,13</b>	-	-	-	-	50
2190N004A3		1/2x16x2	●	<b>2,19</b>	-	-	-	-	50

### 220A ADZ brass

Code	Version	Size (D)	Smooth	€	D1	H	L	M	Pack
22000004A2		1/2x15x2,5	●	<b>2,06</b>	-	-	-	-	50
2200N004A2		1/2x15x2,5	●	<b>2,11</b>	-	-	-	-	50

### 219E

Code	Version	Size (D)	Smooth	€	D1	H	I	L	Pack
219E000508		3/4x14X2	●	<b>2,45</b>	-	-	-	-	25
219E00050B		3/4x16X1,8	●	<b>2,45</b>	-	-	-	-	25
219E000503		3/4x16X2	●	<b>2,45</b>	-	-	-	-	25
219E000505		3/4x16X2,25	●	<b>2,45</b>	-	-	-	-	25
219E000506		3/4x17X2	●	<b>2,45</b>	-	-	-	-	25
219E000509		3/4x18X2	●	<b>2,45</b>	-	-	-	-	25
219E00050A		3/4x20X2	●	<b>2,45</b>	-	-	-	-	25
219E00050C		3/4x20X2,25	●	<b>2,45</b>	-	-	-	-	25
219E00050M		3/4x20X2,50	●	<b>2,45</b>	-	-	-	-	25
219EC00508		3/4x14X2	●	<b>2,54</b>	-	-	-	-	25
219EC0050B		3/4x16X1,8	●	<b>2,54</b>	-	-	-	-	25
219EC00503		3/4x16X2	●	<b>2,54</b>	-	-	-	-	25
219EC00505		3/4x16X2,25	●	<b>2,54</b>	-	-	-	-	25
219EC00506		3/4x17X2	●	<b>2,54</b>	-	-	-	-	25
219EC00509		3/4x18X2	●	<b>2,54</b>	-	-	-	-	25
219EC0050A		3/4x20X2	●	<b>2,54</b>	-	-	-	-	25
219EC0050C		3/4x20X2,25	●	<b>2,54</b>	-	-	-	-	25
219EC0050M		3/4x20X2,5	●	<b>2,54</b>	-	-	-	-	25

### 219X connection 24x19

Code	Version	Size (D)	Smooth	€	D1	H	I	L	Pack
219X002403	-	16x2	●	<b>2,16</b>	24x19	-	-	-	25
219X002409	-	18x2	●	<b>2,16</b>	24x19	-	-	-	25
219X00240N	-	18x2,5	●	<b>2,16</b>	24x19	-	-	-	25
219XN02403	-	16x2	●	<b>2,16</b>	24x19	-	-	-	25
219XN02409	-	18x2	●	<b>2,16</b>	24x19	-	-	-	25
219XN0240N	-	18x2,5	●	<b>2,16</b>	24x19	-	-	-	25



Adattatore per tubo  
di plastica  
*Plastic tube adaptor*  
*Adaptador para tubo*  
*de plástico*



Adattatore per tubo  
di plastica tipo Eurocono  
*Plastic tube adaptor*  
*Euroconus type*  
*Adaptador para tubo*  
*de plástico tipo Eurocono*



Adattatore per tubo PVC  
**24X19**  
*Plastic 24x19 tube PVC*  
*adaptor*  
*Adaptador para tubo PVC*  
**24X19**

## 220

Code	Version	Size (D)	Smooth	€	D1	H	I	L	Pack
2200000401		1/2x12X2	●	1,74	-	-	-	-	50
2200000408		1/2x14X2	●	1,74	-	-	-	-	50
2200000402		1/2x15X2,5	●	1,74	-	-	-	-	50
220000040B		1/2x16X1,8	●	1,74	-	-	-	-	50
2200000403		1/2x16X2	●	1,74	-	-	-	-	50
2200000404		1/2x16X2,2	●	1,74	-	-	-	-	50
2200N00401		1/2x12X2	●	1,80	-	-	-	-	50
2200N00408		1/2x14X2	●	1,80	-	-	-	-	50
2200N0040D		1/2x15X2	●	1,80	-	-	-	-	50
2200N00402		1/2x15X2,5	●	1,80	-	-	-	-	50
2200N0040B		1/2x16X1,8	●	1,80	-	-	-	-	50
2200N00403		1/2x16X2	●	1,80	-	-	-	-	50
2200N00404		1/2x16X2,2	●	1,80	-	-	-	-	50

## 220E

Code	Version	Size (D)	Smooth	€	D1	H	I	L	Pack
220E000401		3/4x12x2	●	2,36	-	-	-	-	2
220E000408		3/4x14X2	●	2,36	-	-	-	-	25
220E000402		3/4x15X2,5	●	2,36	-	-	-	-	25
220E00040B		3/4x16X1,8	●	2,36	-	-	-	-	25
220E000403		3/4x16X2	●	2,36	-	-	-	-	25
220E000404		3/4x16X2,25	●	2,36	-	-	-	-	25
220E000406		3/4x17X2	●	2,36	-	-	-	-	25
220E000409		3/4x18X2	●	2,36	-	-	-	-	25
220E00040E		3/4x20X1,8	●	2,36	-	-	-	-	25
220E00040A		3/4x20X2	●	2,36	-	-	-	-	25
220E00040C		3/4x20X2,25	●	2,36	-	-	-	-	25
220E00040G		3/4x22X2,5	●	2,36	-	-	-	-	25
220EC00401		3/4x12x2	●	2,43	-	-	-	-	25
220EC00408		3/4x14X2	●	2,43	-	-	-	-	25
220EC00402		3/4x15X2,5	●	2,43	-	-	-	-	25
220EC0040B		3/4x16X1,8	●	2,43	-	-	-	-	25
220EC00403		3/4x16X2	●	2,43	-	-	-	-	25
220EC00404		3/4x16X2,25	●	2,43	-	-	-	-	25
220EC00406		3/4x17X2	●	2,43	-	-	-	-	25
220EC00409		3/4x18X2	●	2,43	-	-	-	-	25
220EC0040E		3/4x20X1,8	●	2,43	-	-	-	-	25
220EC0040A		3/4x20X2	●	2,43	-	-	-	-	25
220EC0040C		3/4x20X2,25	●	2,43	-	-	-	-	25

## 220X

### connection 24x19

Code	Version	Size (D)	Smooth	€	D1	H	I	L	Pack
220X002402	-	15x2,5	●	2,11	-	-	-	-	25
220X002403	-	16x2	●	2,11	-	-	-	-	25
220X002409	-	18x2	●	2,11	-	-	-	-	25
220X00240N	-	18x2,5	●	2,11	-	-	-	-	25
220XN02402	-	15x2,5	●	2,11	-	-	-	-	25
220XN02403	-	16x2	●	2,11	-	-	-	-	25
220XN02409	-	18x2	●	2,11	-	-	-	-	25
220XN0240N	-	18x2,5	●	2,11	-	-	-	-	25



Riduzione per collettore FF  
*female-female reducer for manifold*  
*Reductor para colector HH*

### 226

Code	Version	Size (D)	Smooth	€	D1	H	I	L	Pack
2260050300		3/4	●	<b>1,52</b>	3/8	17	-	-	50
2260C50300		3/4	●	<b>1,62</b>	3/8	17	-	-	50
2260060300		1"	●	<b>2,08</b>	3/8	19	-	-	50
2260C60300		1"	●	<b>2,21</b>	3/8	19	-	-	50

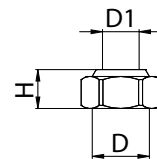

Tappo femmina con guarnizione per collettore  
*Female plug for manifold with sealing*  
*Tapón hembra para colector con junta*

### 227

Code	Version	Size (D)	Smooth	€	D1	H	I	L	Pack
2270000400		1/2	●	<b>0,83</b>	-	12	-	-	50
2270C00400		1/2	●	<b>0,89</b>	-	12	-	-	50
2270000500		3/4	●	<b>1,22</b>	-	14	-	-	50
2270C00500		3/4	●	<b>1,30</b>	-	14	-	-	50
2270000600		1"	●	<b>1,70</b>	-	16	-	-	50
2270C00600		1"	●	<b>1,81</b>	-	16	-	-	50

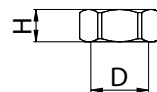

Tappo collettore con derivazione attacco maschio e scarico  
*Plug for manifold with male connection and discharge*  
*Tapón para colector con derivación empalme macho y desagüe*

### 228

Code	Version	Size (D)	Smooth	€	D1	H	I	L	Pack
2280000500		3/4	●	<b>4,22</b>	-	57	-	35	15
2280C00500		3/4	●	<b>4,51</b>	-	57	-	35	15
2280000600		1"	●	<b>4,22</b>	-	57	-	35	15
2280C00600		1"	●	<b>4,51</b>	-	57	-	35	15

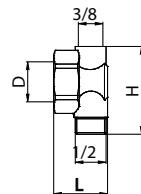

Tappo collettore con derivazione attacco femmina e scarico  
*Plug for manifold with female connection and discharge*  
*Tapón para colector con derivación empalme hembra y desagüe*

### 228B

Code	Version	Size (D)	Smooth	€	D1	H	I	L	Pack
228B000600		1"	●	<b>4,22</b>	-	57	-	35	15
228BC00600		1"	●	<b>4,51</b>	-	57	-	35	15

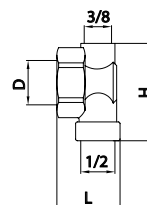



Tappo collettore  
preguarnito con derivazione  
attacco femmina e scarico  
*Plug for manifold  
with teflon ring, female  
connection and discharge*  
*Tapón para colector  
con guarnición de teflon  
y con derivación empalme  
hembra y desagüe*

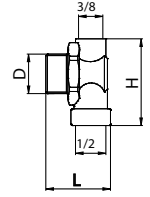

**229**

Code	Version	Size (D)	Smooth	€	D1	H	I	L	Pack
2290000500		3/4	●	<b>4,09</b>	-	57	-	40	15
2290C00500		3/4	●	<b>4,44</b>	-	57	-	40	15
2290000600		1"	●	<b>4,14</b>	-	57	-	42	15
2290C00600		1"	●	<b>4,49</b>	-	57	-	42	15
2290000700		1"1/4	●	<b>9,06</b>	-	57	-	48	15
2290C00700		1"1/4	●	<b>9,59</b>	-	57	-	48	15

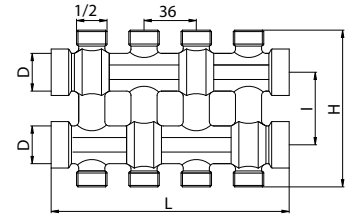

**230**

Code	Version	Size (D)	Smooth	€	D1	H	I	L	Pack
2304000500	-	3/4	●	<b>28,92</b>	-	108	50	164	2
2304000600	-	1"	●	<b>35,09</b>	-	116	52	164	2
<b>4 vie - 4 ways - 4 vías</b>									
2306000500	-	3/4	●	<b>37,96</b>	-	108	50	236	2
2306000600	-	1"	●	<b>48,71</b>	-	116	52	236	2
<b>6 vie - 6 ways - 6 vías</b>									



Collettore complanare  
componibile attacchi laterali  
1/2x16mm  
*Double pattern manifold with  
offtakes 1/2x16mm*  
*Colector coplanar modular  
empalmes laterales 1/2x16mm*

**231**

Code	Version	Size (D)	Smooth	€	D1	H	I	L	Pack
2310000400		1/2	●	<b>1,00</b>	-	15	-	-	50
2310C00400		1/2	●	<b>1,06</b>	-	15	-	-	50
2310000500		3/4	●	<b>1,59</b>	-	16	-	-	50
2310C00500		3/4	●	<b>1,66</b>	-	16	-	-	50
2310000600		1"	●	<b>2,35</b>	-	20	-	-	50
2310C00600		1"	●	<b>2,44</b>	-	20	-	-	50



Tappo maschio con OR per  
collettore  
*Male plug with O-Ring for  
manifold*  
*Tapón macho con O-Ring  
para colector*

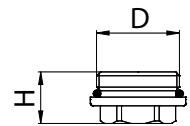

**231B**

Code	Version	Size (D)	Smooth	€	D1	H	I	L	Pack
231B050301		3/4x3/8	●	<b>1,60</b>	3/8	19	-	-	50
231BC50301		3/4x3/8	●	<b>1,69</b>	3/8	19	-	-	50
231B050401		3/4x1/2	●	<b>1,52</b>	1/2	20	-	-	50
231BC50401		3/4x1/2	●	<b>1,61</b>	1/2	20	-	-	50
231B060301		1"x3/8	●	<b>2,35</b>	3/8	20	-	-	50
231BC60301		1"x3/8	●	<b>2,44</b>	3/8	20	-	-	50
231B060401		1"x1/2	●	<b>2,47</b>	1/2	20	-	-	50
231BC60401		1"x1/2	●	<b>2,57</b>	1/2	20	-	-	50
231B060501		1"x3/4	●	<b>2,65</b>	3/4	20	-	-	50
231BC60501		1"x3/4	●	<b>2,76</b>	3/4	20	-	-	50



Riduzione MF con OR per  
collettore  
*Male-female reducer with  
O-Ring for manifold*  
*Reductor MH con O-Ring  
para colector*

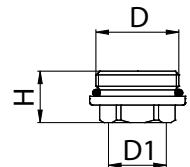



Raccordo Eurocono con OR per collettore  
*Euroconus fitting with O-Ring for manifold*  
*Racores Eurocono con O-Ring para colector*



Collettore da barra con attacchi maschio 3/4 Eurocono, valvole incorporate, interasse 50mm  
*Manifold made of brass rod with 3/4 Euroconus male offtakes and incorporated valves, interaxis 50mm*  
*Colector de barra con empalmes macho Eurocono 3/4, válvulas incorporadas, distancia entre ejes 50mm*

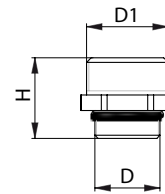

### 242ER

Code	Version	Size (D)	Smooth	€	D1	H	I	L	Pack
242ER00500		1/2	●	<b>1,36</b>	3/4	26	-	-	50

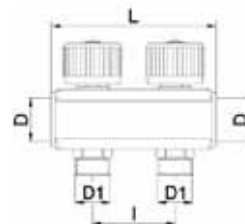

### 232E÷240E

Code	Version	Size (D)	Smooth	€	D1	H	I	L	Pack
232E05050_	A/D	3/4	●	<b>16,18</b>	3/4	-	50	102	6
232E06050_	A/D	1"	●	<b>18,03</b>	3/4	-	50	102	4
<b>2 vie - 2 ways - 2 vías</b>									
233E05050_	A/D	3/4	●	<b>23,88</b>	3/4	-	50	152	4
233E06050_	A/D	1"	●	<b>26,50</b>	3/4	-	50	152	4
<b>3 vie - 3 ways - 3 vías</b>									
234E05050_	A/D	3/4	●	<b>31,73</b>	3/4	-	50	202	4
234E06050_	A/D	1"	●	<b>34,68</b>	3/4	-	50	202	4
<b>4 vie - 4 ways - 4 vías</b>									
235E05050_	A/D	3/4	●	<b>39,74</b>	3/4	-	50	252	2
235E06050_	A/D	1"	●	<b>43,47</b>	3/4	-	50	252	2
<b>5 vie - 5 ways - 5 vías</b>									
236E05050_	A/D	3/4	●	<b>46,39</b>	3/4	-	50	302	2
236E06050_	A/D	1"	●	<b>51,52</b>	3/4	-	50	302	2
<b>6 vie - 6 ways - 6 vías</b>									
237E06050_	A/D	1"	●	<b>58,86</b>	3/4	-	50	352	2
<b>7 vie - 7 ways - 7 vías</b>									
238E06050_	A/D	1"	●	<b>66,66</b>	3/4	-	50	402	2
<b>8 vie - 8 ways - 8 vías</b>									
239E06050_	A/D	1"	●	<b>74,57</b>	3/4	-	50	452	2
<b>9 vie - 9 ways - 9 vías</b>									
240E06050_	A/D	1"	●	<b>82,48</b>	3/4	-	50	502	2
<b>10 vie - 10 ways - 10 vías</b>									



Collettore da barra con attacchi maschio 1/2, interasse 50mm

Manifold made of brass rod with 1/2 male offtakes, interaxis 50mm

Colector de barra con empalmes macho 1/2, distancia entre ejes 50mm

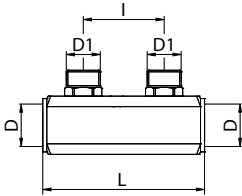

**242÷250**

Code	Version	Size (D)	Smooth	€	D1	H	I	L	Pack
2420050400		3/4	●	<b>10,19</b>	1/2	-	50	102	8
2420060400		1"	●	<b>12,19</b>	1/2	-	50	102	6
2420070400		1" 1/4	●	<b>14,65</b>	1/2	-	50	102	4
<b>2 vie - 2 ways - 2 vías</b>									
2430050400		3/4	●	<b>15,12</b>	1/2	-	50	152	6
2430060400		1"	●	<b>16,84</b>	1/2	-	50	152	4
2430070400		1" 1/4	●	<b>20,89</b>	1/2	-	50	152	4
<b>3 vie - 3 ways - 3 vías</b>									
2440050400		3/4	●	<b>20,46</b>	1/2	-	50	202	6
2440060400		1"	●	<b>22,14</b>	1/2	-	50	202	4
2440070400		1" 1/4	●	<b>27,88</b>	1/2	-	50	202	3
<b>4 vie - 4 ways - 4 vías</b>									
2450050400		3/4	●	<b>25,10</b>	1/2	-	50	252	4
2450060400		1"	●	<b>28,08</b>	1/2	-	50	252	4
2450070400		1" 1/4	●	<b>34,68</b>	1/2	-	50	252	2
<b>5 vie - 5 ways - 5 vías</b>									
2460050400		3/4	●	<b>29,72</b>	1/2	-	50	302	4
2460060400		1"	●	<b>32,99</b>	1/2	-	50	302	4
2460070400		1" 1/4	●	<b>40,50</b>	1/2	-	50	302	3
<b>6 vie - 6 ways - 6 vías</b>									
2470050400		3/4	●	<b>35,77</b>	1/2	-	50	352	1
2470060400		1"	●	<b>38,39</b>	1/2	-	50	352	1
2470070400		1" 1/4	●	<b>47,20</b>	1/2	-	50	352	1
<b>7 vie - 7 ways - 7 vías</b>									
2480050400		3/4	●	<b>39,71</b>	1/2	-	50	402	1
2480060400		1"	●	<b>44,43</b>	1/2	-	50	402	1
2480070400		1" 1/4	●	<b>54,21</b>	1/2	-	50	402	1
<b>8 vie - 8 ways - 8 vías</b>									
2490050400		3/4	●	<b>45,47</b>	1/2	-	50	452	1
2490060400		1"	●	<b>49,35</b>	1/2	-	50	452	1
2490070400		1" 1/4	●	<b>60,14</b>	1/2	-	50	452	1
<b>9 vie - 9 ways - 9 vías</b>									
2500050400		3/4	●	<b>50,43</b>	1/2	-	50	502	1
2500060400		1"	●	<b>54,31</b>	1/2	-	50	502	1
2500070400		1" 1/4	●	<b>67,29</b>	1/2	-	50	502	1
<b>10 vie - 10 ways - 10 vías</b>									



Collettore da barra  
con attacchi maschio 3/4  
Eurocono interasse 50mm,  
uscite maschio

Manifold brass rod  
with 3/4 male offtakes,  
type Eurocono,  
interaxis 50mm

Colector de barra  
con empalmes macho 3/4  
Eurocono, distancia entre ejes  
50mm, salidas macho

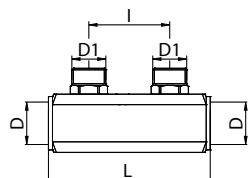

### 242E÷250E

Code	Version	Size (D)	Smooth	€	D1	H	I	L	Pack
242E050500		3/4	●	<b>10,49</b>	3/4	-	50	102	6
242E060500		1"	●	<b>11,95</b>	3/4	-	50	102	6
242E070500		1" 1/4	●	<b>14,61</b>	3/4	-	50	102	4
<b>2 vie - 2 ways - 2 vías</b>									
243E050500		3/4	●	<b>15,43</b>	3/4	-	50	152	4
243E060500		1"	●	<b>17,41</b>	3/4	-	50	152	4
243E070500		1" 1/4	●	<b>21,04</b>	3/4	-	50	152	3
<b>3 vie - 3 ways - 3 vías</b>									
244E050500		3/4	●	<b>20,87</b>	3/4	-	50	202	4
244E060500		1"	●	<b>22,92</b>	3/4	-	50	202	4
244E070500		1" 1/4	●	<b>27,86</b>	3/4	-	50	202	4
<b>4 vie - 4 ways - 4 vías</b>									
245E050500		3/4	●	<b>26,61</b>	3/4	-	50	252	3
245E060500		1"	●	<b>28,52</b>	3/4	-	50	252	3
245E070500		1" 1/4	●	<b>34,46</b>	3/4	-	50	252	3
<b>5 vie - 5 ways - 5 vías</b>									
246E050500		3/4	●	<b>30,18</b>	3/4	-	50	302	4
246E060500		1"	●	<b>33,83</b>	3/4	-	50	302	4
246E070500		1" 1/4	●	<b>41,40</b>	3/4	-	50	302	2
<b>6 vie - 6 ways - 6 vías</b>									
247E050500		3/4	●	<b>35,53</b>	3/4	-	50	352	1
247E060500		1"	●	<b>39,20</b>	3/4	-	50	352	1
247E070500		1" 1/4	●	<b>48,38</b>	3/4	-	50	352	1
<b>7 vie - 7 ways - 7 vías</b>									
248E050500		3/4	●	<b>40,15</b>	3/4	-	50	402	1
248E060500		1"	●	<b>45,55</b>	3/4	-	50	402	1
248E070500		1" 1/4	●	<b>54,33</b>	3/4	-	50	402	1
<b>8 vie - 8 ways - 8 vías</b>									
249E050500		3/4	●	<b>45,17</b>	3/4	-	50	452	1
249E060500		1"	●	<b>50,81</b>	3/4	-	50	452	1
249E070500		1" 1/4	●	<b>61,46</b>	3/4	-	50	452	1
<b>9 vie - 9 ways - 9 vías</b>									
250E050500		3/4	●	<b>50,73</b>	3/4	-	50	502	1
250E060500		1"	●	<b>55,84</b>	3/4	-	50	502	1
250E070500		1" 1/4	●	<b>68,41</b>	3/4	-	50	502	1
<b>10 vie - 10 ways - 10 vías</b>									
250E060501		1"	●	<b>60,92</b>	3/4	-	50	552	1
<b>11 vie - 11 ways - 11 vías</b>									
250E060502		1"	●	<b>66,14</b>	3/4	-	50	602	1
<b>12 vie - 12 ways - 12 vías</b>									



Collettore da barra attacchi maschio 3/4 Eurocono e foro di scarico 3/8", interasse 50mm

*Brass rod manifold with 3/4 Euroconus male offtakes and 3/8" drain hole, interaxis 50mm*

*Colector de barra con empalmes macho 3/4 Eurocono, agujero de desagüe 3/8", distancia entre ejes 50mm*

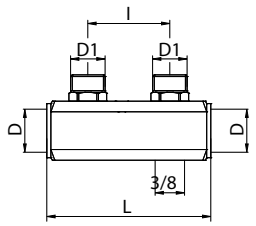

**242EA÷250EA**

Code	Version	Size (D)	Smooth	€	D1	H	I	L	Pack
242EA60500		1"	●	<b>12,08</b>	3/4	-	50	102	6
2 vie - 2 ways - 2 vías									
243EA60500		1"	●	<b>17,54</b>	3/4	-	50	152	4
3 vie - 3 ways - 3 vías									
244EA60500		1"	●	<b>23,05</b>	3/4	-	50	202	4
4 vie - 4 ways - 4 vías									
245EA60500		1"	●	<b>28,65</b>	3/4	-	50	252	3
5 vie - 5 ways - 5 vías									
246EA60500		1"	●	<b>33,96</b>	3/4	-	50	302	4
6 vie - 6 ways - 6 vías									
247EA60500		1"	●	<b>39,33</b>	3/4	-	50	352	1
7 vie - 7 ways - 7 vías									
248EA60500		1"	●	<b>45,68</b>	3/4	-	50	402	1
8 vie - 8 ways - 8 vías									
249EA60500		1"	●	<b>50,94</b>	3/4	-	50	452	1
9 vie - 9 ways - 9 vías									
250EA60500		1"	●	<b>55,97</b>	3/4	-	50	502	1
10 vie - 10 ways - 10 vías									
250EA60501		1"	●	<b>61,05</b>	3/4	-	50	552	1
11 vie - 11 ways - 11 vías									
250EA60502		1"	●	<b>66,27</b>	3/4	-	50	602	1
12 vie - 12 ways - 12 vías									





Collettore da barra  
con attacchi femmina 1/2,  
interasse 50mm

Manifold made of brass rod  
with 1/2 female offtakes,  
interaxis 50mm

Colector de barra  
con empalmes hembra 1/2,  
distancia entre ejes 50mm

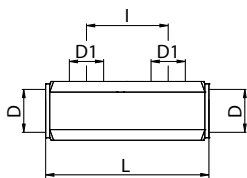

## 252÷262

Code	Version	Size (D)	Smooth	€	D1	H	I	L	Pack
2520050400		3/4	●	<b>7,23</b>	1/2	-	50	102	8
2520060400		1"	●	<b>8,72</b>	1/2	-	50	102	8
2520070400		1" 1/4	●	<b>10,81</b>	1/2	-	50	102	5
<b>2 vie - 2 ways - 2 vías</b>									
2530050400		3/4	●	<b>10,56</b>	1/2	-	50	152	6
2530060400		1"	●	<b>12,69</b>	1/2	-	50	152	6
2530070400		1" 1/4	●	<b>16,42</b>	1/2	-	50	152	4
<b>3 vie - 3 ways - 3 vías</b>									
2540050400		3/4	●	<b>14,30</b>	1/2	-	50	202	6
2540060400		1"	●	<b>16,65</b>	1/2	-	50	202	6
2540070400		1" 1/4	●	<b>21,31</b>	1/2	-	50	202	4
<b>4 vie - 4 ways - 4 vías</b>									
2550050400		3/4	●	<b>18,56</b>	1/2	-	50	252	6
2550060400		1"	●	<b>20,73</b>	1/2	-	50	252	4
2550070400		1" 1/4	●	<b>26,52</b>	1/2	-	50	252	2
<b>5 vie - 5 ways - 5 vías</b>									
2560050400		3/4	●	<b>21,00</b>	1/2	-	50	302	4
2560060400		1"	●	<b>24,66</b>	1/2	-	50	302	4
2560070400		1" 1/4	●	<b>31,94</b>	1/2	-	50	302	3
<b>6 vie - 6 ways - 6 vías</b>									
2570050400		3/4	●	<b>25,26</b>	1/2	-	50	352	4
2570060400		1"	●	<b>28,87</b>	1/2	-	50	352	4
2570070400		1" 1/4	●	<b>36,91</b>	1/2	-	50	352	2
<b>7 vie - 7 ways - 7 vías</b>									
2580050400		3/4	●	<b>28,40</b>	1/2	-	50	402	1
2580060400		1"	●	<b>32,72</b>	1/2	-	50	402	1
2580070400		1" 1/4	●	<b>42,06</b>	1/2	-	50	402	1
<b>8 vie - 8 ways - 8 vías</b>									
2590050400		3/4	●	<b>31,28</b>	1/2	-	50	452	1
2590060400		1"	●	<b>36,95</b>	1/2	-	50	452	1
2590070400		1" 1/4	●	<b>47,79</b>	1/2	-	50	452	1
<b>9 vie - 9 ways - 9 vías</b>									
2600050400		3/4	●	<b>34,57</b>	1/2	-	50	502	1
2600060400		1"	●	<b>40,88</b>	1/2	-	50	502	1
2600070400		1" 1/4	●	<b>53,00</b>	1/2	-	50	502	1
<b>10 vie - 10 ways - 10 vías</b>									
2610060400		1"	●	<b>45,51</b>	1/2	-	50	552	1
2610070400		1" 1/4	●	<b>58,38</b>	1/2	-	50	552	1
<b>11 vie - 11 ways - 11 vías</b>									
2620060400		1"	●	<b>48,76</b>	1/2	-	50	602	1
2620070400		1" 1/4	●	<b>64,41</b>	1/2	-	50	602	1
<b>12 vie - 12 ways - 12 vías</b>									



Collettore da barra con attacchi femmina 1/2, interasse 50mm, con foro di scarico 3/8"  
Manifold made of brass rod with 1/2 female offtakes, interaxis 50mm, with drain hole of 3/8"

Colector de barra con empalmes hembra 1/2, distancia entre ejes 50mm, con agujero de desagüe 3/8"

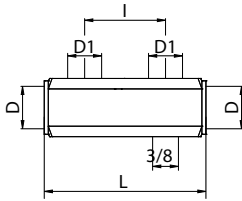

## 252A÷262A

Code	Version	Size (D)	Smooth	€	D1	H	I	L	Pack
252A050400		3/4	●	<b>7,36</b>	1/2	-	50	102	8
252A060400		1"	●	<b>8,84</b>	1/2	-	50	102	8
252A070400		1" 1/4	●	<b>10,94</b>	1/2	-	50	102	5
<b>2 vie - 2 ways - 2 vías</b>									
253A050400		3/4	●	<b>10,69</b>	1/2	-	50	152	6
253A060400		1"	●	<b>12,82</b>	1/2	-	50	152	6
253A070400		1" 1/4	●	<b>16,55</b>	1/2	-	50	152	4
<b>3 vie - 3 ways - 3 vías</b>									
254A050400		3/4	●	<b>14,43</b>	1/2	-	50	202	6
254A060400		1"	●	<b>16,71</b>	1/2	-	50	202	6
254A070400		1" 1/4	●	<b>21,43</b>	1/2	-	50	202	4
<b>4 vie - 4 ways - 4 vías</b>									
255A050400		3/4	●	<b>18,69</b>	1/2	-	50	252	6
255A060400		1"	●	<b>20,84</b>	1/2	-	50	252	4
255A070400		1" 1/4	●	<b>26,65</b>	1/2	-	50	252	2
<b>5 vie - 5 ways - 5 vías</b>									
256A050400		3/4	●	<b>21,13</b>	1/2	-	50	302	4
256A060400		1"	●	<b>24,47</b>	1/2	-	50	302	4
256A070400		1" 1/4	●	<b>32,07</b>	1/2	-	50	302	3
<b>6 vie - 6 ways - 6 vías</b>									
257A050400		3/4	●	<b>25,39</b>	1/2	-	50	352	4
257A060400		1"	●	<b>28,99</b>	1/2	-	50	352	4
257A070400		1" 1/4	●	<b>37,03</b>	1/2	-	50	352	2
<b>7 vie - 7 ways - 7 vías</b>									
258A050400		3/4	●	<b>28,53</b>	1/2	-	50	402	1
258A060400		1"	●	<b>32,85</b>	1/2	-	50	402	1
258A070400		1" 1/4	●	<b>42,19</b>	1/2	-	50	402	1
<b>8 vie - 8 ways - 8 vías</b>									
259A050400		3/4	●	<b>31,41</b>	1/2	-	50	452	1
259A060400		1"	●	<b>37,07</b>	1/2	-	50	452	1
259A070400		1" 1/4	●	<b>47,92</b>	1/2	-	50	452	1
<b>9 vie - 9 ways - 9 vías</b>									
260A050400		3/4	●	<b>34,70</b>	1/2	-	50	502	1
260A060400		1"	●	<b>41,00</b>	1/2	-	50	502	1
260A070400		1" 1/4	●	<b>53,13</b>	1/2	-	50	502	1
<b>10 vie - 10 ways - 10 vías</b>									
261A060400		1"	●	<b>45,64</b>	1/2	-	50	552	1
<b>11 vie - 11 ways - 11 vías</b>									
262A060400		1"	●	<b>48,89</b>	1/2	-	50	602	1
<b>12 vie - 12 ways - 12 vías</b>									



Collettore da barra con attacchi femmina 1/2, interasse 50mm con fori passanti

*Manifold made of brass rod with 1/2 female offtakes, interaxis 50mm, with double holes.*

*Colector de barra con empalmes hembra 1/2, distancia entre ejes 50mm, con doble salida.*

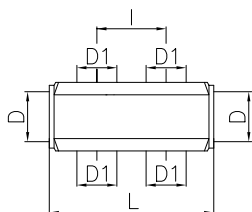

### 252B÷262B

Code	Version	Size (D)	Smooth	€	D1	H	I	L	Pack
252B060400		1"	●	<b>8,63</b>	1/2	-	50	102	8
2 vie - 2 ways - 2 vías									
253B060400		1"	●	<b>12,76</b>	1/2	-	50	152	6
3 vie - 3 ways - 3 vías									
254B060400		1"	●	<b>16,83</b>	1/2	-	50	202	6
4 vie - 4 ways - 4 vías									
255B060400		1"	●	<b>20,83</b>	1/2	-	50	252	4
5 vie - 5 ways - 5 vías									
256B060400		1"	●	<b>24,89</b>	1/2	-	50	302	4
6 vie - 6 ways - 6 vías									
257B060400		1"	●	<b>28,98</b>	1/2	-	50	352	4
7 vie - 7 ways - 7 vías									
258B060400		1"	●	<b>32,95</b>	1/2	-	50	402	1
8 vie - 8 ways - 8 vías									
259B060400		1"	●	<b>37,09</b>	1/2	-	50	452	1
9 vie - 9 ways - 9 vías									
260B060400		1"	●	<b>41,12</b>	1/2	-	50	502	1
10 vie - 10 ways - 10 vías									
261B060400		1"	●	<b>45,04</b>	1/2	-	50	552	1
11 vie - 11 ways - 11 vías									
262B060400		1"	●	<b>48,77</b>	1/2	-	50	602	1
12 vie - 12 ways - 12 vías									



Cassetta in lamiera verniciata per collettori con profondità regolabile

*Regulating iron box for manifolds*

*Caja de inspección de chapa cincada barnizada de blanco para colectores*

### 269

Code	Version	Size (D)	Smooth	€	D1	H	I	L	Pack
2690050000		500x630x110		<b>112,74</b>	-	-	-	-	1
2690070000		700x630x110		<b>132,72</b>	-	-	-	-	1
2690085000		850x630x110		<b>154,35</b>	-	-	-	-	1
2690100000		1000x630x110		<b>171,26</b>	-	-	-	-	1
2690050090		500x630x90		<b>112,74</b>	-	-	-	-	1
2690070090		700x630x90		<b>132,72</b>	-	-	-	-	1
2690085090		850x630x90		<b>154,35</b>	-	-	-	-	1
2690100090		1000x630x90		<b>171,26</b>	-	-	-	-	1



Cassetta in plastica per collettori

*Plastic box for manifolds*

*Caja de plástico para colectores*

### 270

Code	Version	Size (D)	Smooth	€	D1	H	I	L	Pack
2700035000		350x350x90		<b>23,59</b>	-	-	-	-	1
2700050000		500x350x90		<b>29,67</b>	-	-	-	-	1
2700065000		650x350x90		<b>39,68</b>	-	-	-	-	1



Kit fissaggio collettori coplanari

*Coplanar manifold's fixing set*

*Kit fijación colectores coplanares modulares*

### 270CC

Code	Version	Size (D)	Smooth	€	D1	H	I	L	Pack
270CC00000	-	-	-	<b>2,75</b>	-	-	-	-	25



Kit fissaggio collettori Manifold's fixing set

*Kit fijación colectores*

### 270CS

Code	Version	Size (D)	Smooth	€	D1	H	I	L	Pack
270CS00000	-	-	-	<b>4,72</b>	-	-	-	-	25



Staffa per collettori da barra

*Support for brass bar manifold*

*Soportes para colectores*

### 271

Code	Version	Size (D)	Smooth	€	D1	H	I	L	Pack
2710000500		3/4		<b>6,64</b>	-	-	-	-	2
2710000000		1"		<b>6,64</b>	-	-	-	-	2
2710000700		1" 1/4		<b>6,79</b>	-	-	-	-	2



Staffa singola  
Single bracket  
Solo soporte

### 271 S

Code	Version	Size (D)	Smooth	€	D1	H	I	L	Pack
271S000500		3/4		<b>5,07</b>	-	-	-	-	2
271S000000		1"		<b>5,07</b>	-	-	-	-	2
271S000700		1" 1/4		<b>5,07</b>	-	-	-	-	2

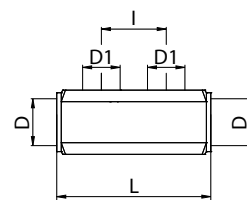

Collettore da barra  
con attacchi femmina 1/2,  
interasse 36mm  
Manifold made of brass rod  
with 1/2 female offtakes,  
interaxis 36mm  
Colector de barra  
con empalmes hembra 1/2,  
distancia entre ejes 36mm

### 272÷280

Code	Version	Size (D)	Smooth	€	D1	H	I	L	Pack
2720050400		3/4	●	<b>6,77</b>	1/2	-	36	86	8
2720060400		1"	●	<b>8,03</b>	1/2	-	36	86	8
<b>2 vie - 2 ways - 2 vías</b>									
2730050400		3/4	●	<b>9,27</b>	1/2	-	36	122	6
2730060400		1"	●	<b>11,46</b>	1/2	-	36	122	6
<b>3 vie - 3 ways - 3 vías</b>									
2740050400		3/4	●	<b>11,37</b>	1/2	-	36	158	6
2740060400		1"	●	<b>14,04</b>	1/2	-	36	158	6
<b>4 vie - 4 ways - 4 vías</b>									
2750050400		3/4	●	<b>14,44</b>	1/2	-	36	194	6
2750060400		1"	●	<b>17,72</b>	1/2	-	36	194	6
<b>5 vie - 5 ways - 5 vías</b>									
2760050400		3/4	●	<b>16,64</b>	1/2	-	36	230	6
2760060400		1"	●	<b>21,16</b>	1/2	-	36	230	6
<b>6 vie - 6 ways - 6 vías</b>									
2770050400		3/4	●	<b>19,95</b>	1/2	-	36	266	6
2770060400		1"	●	<b>24,74</b>	1/2	-	36	266	4
<b>7 vie - 7 ways - 7 vías</b>									
2780050400		3/4	●	<b>22,50</b>	1/2	-	36	302	6
2780060400		1"	●	<b>27,88</b>	1/2	-	36	302	4
<b>8 vie - 8 ways - 8 vías</b>									
2790050400		3/4	●	<b>24,92</b>	1/2	-	36	338	1
2790060400		1"	●	<b>30,82</b>	1/2	-	36	338	1
<b>9 vie - 9 ways - 9 vías</b>									
2800050400		3/4	●	<b>27,65</b>	1/2	-	36	374	1
2800060400		1"	●	<b>34,16</b>	1/2	-	36	374	1
<b>10 vie - 10 ways - 10 vías</b>									



Portatermometro preguarnito  
*Thermometer holder*  
Portatermómetro preguarnito

**297**

Code	Version	Size (D)	Smooth	€	D1	H	I	L	Pack
2970000600		1"	●	<b>4,69</b>	3/8	-	-	55,5	10
2970N00600		1"	●	<b>4,92</b>	3/8	-	-	55,5	10

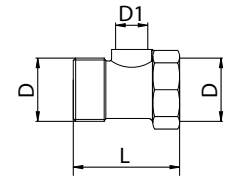

Terminale per collettore con  
valvola sfogo aria automatica  
e rubinetto di scarico  
*Terminal parts for manifold  
with automatic air discharge  
valve and drain ball valve*  
*Tapón terminal con purgador  
automatico y válvula  
de vaciado*

**298**

Code	Version	Size (D)	Smooth	€	D1	H	I	L	Pack
2980000500		3/4	●	<b>18,28</b>	-	150	-	48	5
2980000600		1"	●	<b>18,28</b>	-	150	-	48	5
2980N00600		1"	●	<b>19,21</b>	-	150	-	48	5
2980000700		1" 1/4	●	<b>23,51</b>	-	150	-	48	5
2980N00700		1" 1/4	●	<b>24,69</b>	-	150	-	48	5

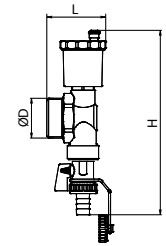

Terminale per collettore con  
valvola sfogo aria manuale  
e rubinetto di scarico  
*Terminal parts for manifold  
with manual air discharge  
valve and drain ball valve*  
*Tapón terminal con purgador  
y válvula de vaciado*

**299**

Code	Version	Size (D)	Smooth	€	D1	H	I	L	Pack
2990000500		3/4	●	<b>13,81</b>	-	120	-	42	5
2990000600		1"	●	<b>13,81</b>	-	120	-	42	5
2990N00600		1"	●	<b>14,34</b>	-	120	-	42	5
2990000700		1" 1/4	●	<b>20,11</b>	-	120	-	42	5
2990N00700		1" 1/4	●	<b>21,12</b>	-	120	-	42	5

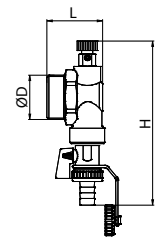

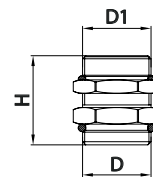

Niplo con OR  
*Nipple with OR*  
*Nipple con junta OR*

**731**

Code	Version	Size (D)	Smooth	€	D1	H	I	L	M	Pack
7310C00600		1"	●	<b>3,57</b>	1"	28	-	-	-	25

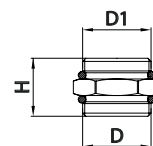

Niplo con OR  
preguarnito con ghiera  
*Nipple with immediate  
sealing and OR*  
*Nipple con junta OR y  
tuerca*

**732**

Code	Version	Size (D)	Smooth	€	D1	H	I	L	M	Pack
7320C00600		1"	●	<b>5,82</b>	1"	43	-	-	-	25

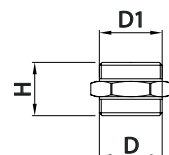

Niplo maschio-  
maschio Eurocono  
*Nipple MM Euroconus*  
*Nipple macho-macho  
Eurocono*

**733**

Code	Version	Size (D)	Smooth	€	D1	H	I	L	M	Pack
7330N00500		3/4	●	<b>2,07</b>	3/4	32	-	-	-	25

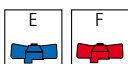
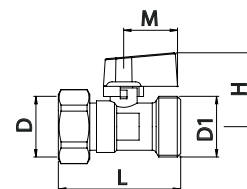

Valvola a sfera di  
giunzione con attacco  
Eurocono  
*Male-Female full bore  
union ball valve with  
Euroconus*  
*Valvula esfera de union  
con conexion Eurocono*

**841**

Code	Version	Size (D)	Smooth	€	D1	H	I	L	M	Pack
841000050_	E/F	3/4 M	●	<b>5,96</b>	3/4 F	33	-	55	24	25

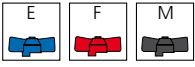

Valvola a sfera MF passaggio totale PN 25 con bocchettone preguarnito, maniglia a farfalla  
*Pipe union and metal ring male-female full bore ball valve PN 25 with T-handle*  
*Válvula de bola con paso total PN 25 con tapón MH y anillo metálico, manija de mariposa*

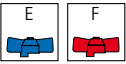

Valvola a sfera MF con bocchettone e termometro Ø 40mm, scala 0-80 °C  
*Pipe union male-female brass ball valve with thermometer Ø 40mm, range 0-80 °C*  
*Válvula de bola para conexión al colector con termómetro 40mm de 0 a 80 °C incorporado*

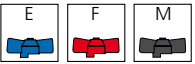

Valvola a sfera ad angolo con bocchettone preguarnito, maniglia a farfalla  
*Angle ball valve with pipe union, T-handle*  
*Válvula de bola de esquadra con anillo metálico, manija y mariposa*

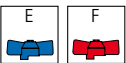

Valvola a sfera ad angolo con bocchettone preguarnito, termometro, maniglia a farfalla  
*Angle ball valve with pipe union, thermometer, T-handle*  
*Válvula de bola de esquadra con anillo metálico, termómetro, manija y mariposa*

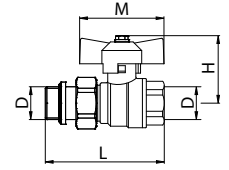

**422BA**

Code	Version	Size (D)	Smooth	€	D1	H	L	M	Pack
422BC004A_	E/F/M	1/2	●	<b>7,53</b>	-	42	80	54	12
422BC005A_	E/F/M	3/4	●	<b>10,46</b>	-	45	87	54	8
422BC006A_	E/F/M	1"	●	<b>15,61</b>	-	51	100	64	5
422BC007A_	E/F	1" 1/4	●	<b>26,70</b>	-	54	126	70	4

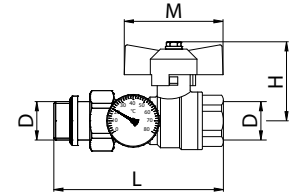

**422M**

Code	Version	Size (D)	Smooth	€	D1	H	M	L	Pack
422M00060_	E/F	1"	●	<b>22,99</b>	-	51	64	118	5
422MC0060_	E/F	1"	●	<b>24,05</b>	-	51	64	118	5
422M00070_	E/F	1" 1/4	●	<b>33,89</b>	-	54	70	164	5
422MC0070_	E/F	1" 1/4	●	<b>35,45</b>	-	54	70	164	5

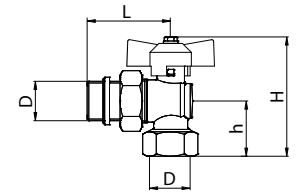

**422R**

Code	Version	Size (D)	Smooth	€	D1	H	h	L	Pack
422R00040_	E/F/M	1/2	●	<b>10,05</b>	-	78	36	55,5	-
422R00050_	E/F/M	3/4	●	<b>13,84</b>	-	83	65	39	8
422R00060_	E/F/M	1"	●	<b>17,53</b>	-	90	69	42,5	5

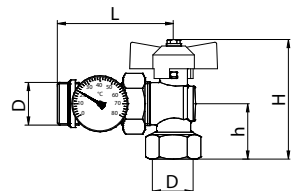

**422RM**

Code	Version	Size (D)	Smooth	€	D1	H	h	L	Pack
422RM0060_	E/F	1"	●	<b>25,52</b>	-	90	42,5	94	5





Termometro bimetallico diametro 40mm  
Scala: 0-80 °C - 32-170 °F  
*Bimetallic thermometer 40mm  
Scale 0-80 °C - 32-170 °F*  
*Termómetro bimetalico 40mm  
Escala: 0-80 °C - 32-170 °F*



Dado con codolo preguarnito e termometro  
*Brass nut and tang with O-Ring and thermometer*  
*Tuerca y vástago con O-Ring y termómetro*



Collettore FF con uscite 3/4" M Eurocono e detentori di regolazione  
*FF manifold with 3/4" M Euroconus outlets and lockshield valves*  
*Colector HH con empalmes 3/4" M Eurocono y detentores*

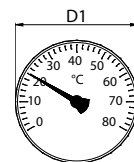
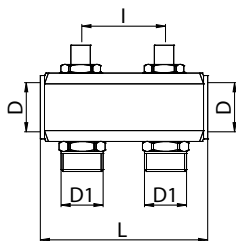

### 448B

Code	Version	Size (D)	Smooth	€	D1	H	I	L	Pack
448B000000		3/8	-	<b>8,13</b>	40	-	-	-	1

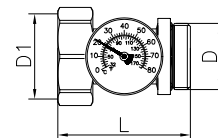

### 396M

Code	Version	Size (D)	Smooth	€	D1	H	I	L	Pack
396M060000		1"	●	<b>13,72</b>	1"1/4	-	-	61	1

### 332D÷340D2

Code	Version	Size (D)	Smooth	€	D1	H	I	L	Pack
332D060500		1"	●	<b>20,63</b>	3/4	-	50	102	1
332D070500		1"1/4	●	<b>23,72</b>	3/4	-	50	102	1
<b>2 vie - 2 ways - 2 vías</b>									
333D060500		1"	●	<b>30,54</b>	3/4	-	50	152	1
333D070500		1"1/4	●	<b>35,32</b>	3/4	-	50	152	1
<b>3 vie - 3 ways - 3 vías</b>									
334D060500		1"	●	<b>40,48</b>	3/4	-	50	202	1
334D070500		1"1/4	●	<b>47,02</b>	3/4	-	50	202	1
<b>4 vie - 4 ways - 4 vías</b>									
335D060500		1"	●	<b>50,42</b>	3/4	-	50	252	1
335D070500		1"1/4	●	<b>58,41</b>	3/4	-	50	252	1
<b>5 vie - 5 ways - 5 vías</b>									
336D060500		1"	●	<b>60,26</b>	3/4	-	50	302	1
336D070500		1"1/4	●	<b>69,00</b>	3/4	-	50	302	1
<b>6 vie - 6 ways - 6 vías</b>									
337D060500		1"	●	<b>70,41</b>	3/4	-	50	352	1
337D070500		1"1/4	●	<b>81,04</b>	3/4	-	50	352	1
<b>7 vie - 7 ways - 7 vías</b>									
338D060500		1"	●	<b>79,58</b>	3/4	-	50	402	1
338D070500		1"1/4	●	<b>92,20</b>	3/4	-	50	402	1
<b>8 vie - 8 ways - 8 vías</b>									
339D060500		1"	●	<b>90,25</b>	3/4	-	50	452	1
339D070500		1"1/4	●	<b>106,76</b>	3/4	-	50	452	1
<b>9 vie - 9 ways - 9 vías</b>									
340D060500		1"	●	<b>100,05</b>	3/4	-	50	502	1
340D070500		1"1/4	●	<b>117,20</b>	3/4	-	50	502	1
<b>10 vie - 10 ways - 10 vías</b>									
340D160500		1"	●	<b>109,93</b>	3/4	-	50	552	1
340D170500		1"1/4	●	<b>129,10</b>	3/4	-	50	552	1
<b>11 vie - 11 ways - 11 vías</b>									
340D260500		1"x3/4	●	<b>119,90</b>	3/4	-	50	602	1
340D270500		1"1/4	●	<b>141,05</b>	3/4	-	50	602	1
<b>12 vie - 12 ways - 12 vías</b>									



Collettore FF con uscite  
3/4" M Eurocono e misuratori  
di portata

FF manifold with 3/4" M  
Euroconus outlets  
with flow meters

Colector HH con empalmes  
3/4" M Eurocono  
y fluxometro

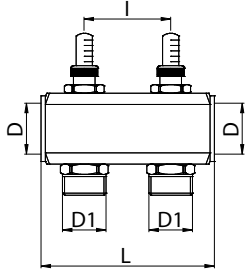

**332M÷340M2**

Code	Version	Size (D)	Smooth	€	D1	H	I	L	Pack
332M060500		1"	●	<b>35,79</b>	3/4	-	50	102	1
332M070500		1"1/4	●	<b>38,42</b>	3/4	-	50	102	1
<b>2 vie - 2 ways - 2 vías</b>									
333M060500		1"	●	<b>54,51</b>	3/4	-	50	152	1
333M070500		1"1/4	●	<b>56,85</b>	3/4	-	50	152	1
<b>3 vie - 3 ways - 3 vías</b>									
334M060500		1"	●	<b>71,91</b>	3/4	-	50	202	1
334M070500		1"1/4	●	<b>75,96</b>	3/4	-	50	202	1
<b>4 vie - 4 ways - 4 vías</b>									
335M060500		1"	●	<b>89,82</b>	3/4	-	50	252	1
335M070500		1"1/4	●	<b>98,23</b>	3/4	-	50	252	1
<b>5 vie - 5 ways - 5 vías</b>									
336M060500		1"	●	<b>107,72</b>	3/4	-	50	302	1
336M070500		1"1/4	●	<b>114,74</b>	3/4	-	50	302	1
<b>6 vie - 6 ways - 6 vías</b>									
337M060500		1"	●	<b>125,24</b>	3/4	-	50	352	1
337M070500		1"1/4	●	<b>133,00</b>	3/4	-	50	352	1
<b>7 vie - 7 ways - 7 vías</b>									
338M060500		1"	●	<b>142,51</b>	3/4	-	50	402	1
338M070500		1"1/4	●	<b>152,95</b>	3/4	-	50	402	1
<b>8 vie - 8 ways - 8 vías</b>									
339M060500		1"	●	<b>160,35</b>	3/4	-	50	452	1
339M070500		1"1/4	●	<b>176,37</b>	3/4	-	50	452	1
<b>9 vie - 9 ways - 9 vías</b>									
340M060500		1"	●	<b>178,38</b>	3/4	-	50	502	1
340M070500		1"1/4	●	<b>197,63</b>	3/4	-	50	502	1
<b>10 vie - 10 ways - 10 vías</b>									
340M160500		1"	●	<b>197,73</b>	3/4	-	50	552	1
340M170500		1"1/4	●	<b>214,64</b>	3/4	-	50	552	1
<b>11 vie - 11 ways - 11 vías</b>									
340M260500		1"	●	<b>217,75</b>	3/4	-	50	602	1
340M270500		1"1/4	●	<b>235,30</b>	3/4	-	50	602	1
<b>12 vie - 12 ways - 12 vías</b>									





Collettori da barra FF con attacchi 3/4" M eurocono con vitone termostatico e detentori.  
Staffe di supporto Art. 271

FF brass rod manifolds with 3/4" male Euroconus outlets, with thermostatic screw and lockshield valves.  
Manifold's brackets Art. 271

Colectores HH con empalmes 3/4" M eurocono con valvulas de regulacion termostizables y detentores.  
Suportes Art. 271

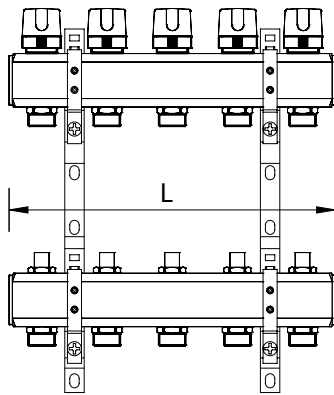

**C312÷C3202**

Code	Version	Size (D)	Smooth	€	D1	H	I	L	Pack
C312060500		1"x3/4	●	<b>52,83</b>	-	-	50	102	1
C312070500		1" 1/4x3/4	●	<b>60,96</b>	-	-	50	102	1
<b>2 vie - 2 ways - 2 vías</b>									
C313060500		1"x3/4	●	<b>78,89</b>	-	-	50	152	1
C313070500		1" 1/4x3/4	●	<b>90,25</b>	-	-	50	152	1
<b>3 vie - 3 ways - 3 vías</b>									
C314060500		1"x3/4	●	<b>99,82</b>	-	-	50	202	1
C314070500		1" 1/4x3/4	●	<b>112,52</b>	-	-	50	202	1
<b>4 vie - 4 ways - 4 vías</b>									
C315060500		1"x3/4	●	<b>121,17</b>	-	-	50	252	1
C315070500		1" 1/4x3/4	●	<b>139,07</b>	-	-	50	252	1
<b>5 vie - 5 ways - 5 vías</b>									
C316060500		1"x3/4	●	<b>142,23</b>	-	-	50	302	1
C316070500		1" 1/4x3/4	●	<b>161,70</b>	-	-	50	302	1
<b>6 vie - 6 ways - 6 vías</b>									
C317060500		1"x3/4	●	<b>164,73</b>	-	-	50	352	1
C317070500		1" 1/4x3/4	●	<b>190,85</b>	-	-	50	352	1
<b>7 vie - 7 ways - 7 vías</b>									
C318060500		1"x3/4	●	<b>184,64</b>	-	-	50	402	1
C318070500		1" 1/4x3/4	●	<b>213,97</b>	-	-	50	402	1
<b>8 vie - 8 ways - 8 vías</b>									
C319060500		1"x3/4	●	<b>206,41</b>	-	-	50	452	1
C319070500		1" 1/4x3/4	●	<b>246,42</b>	-	-	50	452	1
<b>9 vie - 9 ways - 9 vías</b>									
C320060500		1"x3/4	●	<b>227,87</b>	-	-	50	502	1
C320070500		1" 1/4x3/4	●	<b>275,71</b>	-	-	50	502	1
<b>10 vie - 10 ways - 10 vías</b>									
C320160500		1"x3/4	●	<b>254,83</b>	-	-	50	552	1
C320170500		1" 1/4x3/4	●	<b>298,12</b>	-	-	50	552	1
<b>11 vie - 11 ways - 11 vías</b>									
C320260500		1"x3/4	●	<b>271,28</b>	-	-	50	602	1
C320270500		1" 1/4x3/4	●	<b>325,52</b>	-	-	50	602	1
<b>12 vie - 12 ways - 12 vías</b>									



Collettori da barra FF con attacchi 3/4" M eurocono con vitone termostatico e regolatori di flusso a scala graduata.

Staffe di supporto Art. 271

FF brass rod manifolds with 3/4" male Euroconus outlets, with thermostatic screw and flow meters.

Manifold's brackets Art. 271

Colectores HH con empalmes 3/4" M eurocono con valvulas de regulacion termostaticas y fluxometro. Soportes Art. 271

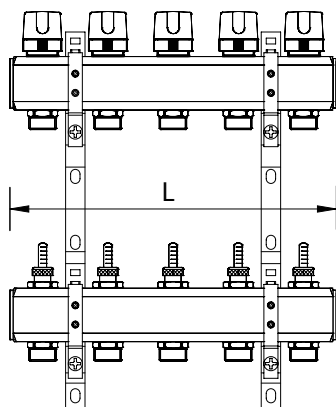

### C322÷C3302

Code	Version	Size (D)	Smooth	€	D1	H	I	L	Pack
C322060500		1"x3/4	●	<b>69,49</b>	-	-	50	102	1
C322070500		1" 1/4x3/4	●	<b>73,92</b>	-	-	50	102	1
<b>2 vie - 2 ways - 2 vías</b>									
C323060500		1"x3/4	●	<b>103,96</b>	-	-	50	152	1
C323070500		1" 1/4x3/4	●	<b>111,79</b>	-	-	50	152	1
<b>3 vie - 3 ways - 3 vías</b>									
C324060500		1"x3/4	●	<b>132,69</b>	-	-	50	202	1
C324070500		1" 1/4x3/4	●	<b>146,49</b>	-	-	50	202	1
<b>4 vie - 4 ways - 4 vías</b>									
C325060500		1"x3/4	●	<b>161,69</b>	-	-	50	252	1
C325070500		1" 1/4x3/4	●	<b>179,30</b>	-	-	50	252	1
<b>5 vie - 5 ways - 5 vías</b>									
C326060500		1"x3/4	●	<b>188,85</b>	-	-	50	302	1
C326070500		1" 1/4x3/4	●	<b>209,54</b>	-	-	50	302	1
<b>6 vie - 6 ways - 6 vías</b>									
C327060500		1"x3/4	●	<b>219,68</b>	-	-	50	352	1
C327070500		1" 1/4x3/4	●	<b>238,55</b>	-	-	50	352	1
<b>7 vie - 7 ways - 7 vías</b>									
C328060500		1"x3/4	●	<b>247,67</b>	-	-	50	402	1
C328070500		1" 1/4x3/4	●	<b>270,69</b>	-	-	50	402	1
<b>8 vie - 8 ways - 8 vías</b>									
C329060500		1"x3/4	●	<b>277,65</b>	-	-	50	452	1
C329070500		1" 1/4x3/4	●	<b>311,27</b>	-	-	50	452	1
<b>9 vie - 9 ways - 9 vías</b>									
C330060500		1"x3/4	●	<b>309,21</b>	-	-	50	502	1
C330070500		1" 1/4x3/4	●	<b>348,60</b>	-	-	50	502	1
<b>10 vie - 10 ways - 10 vías</b>									
C330160500		1"x3/4	●	<b>336,87</b>	-	-	50	552	1
C330170500		1" 1/4x3/4	●	<b>379,41</b>	-	-	50	552	1
<b>11 vie - 11 ways - 11 vías</b>									
C330260500		1"x3/4	●	<b>369,30</b>	-	-	50	602	1
C330270500		1" 1/4x3/4	●	<b>413,05</b>	-	-	50	602	1
<b>12 vie - 12 ways - 12 vías</b>									



Collettori da barra FF con attacchi 3/4" M eurocono con vite termostatica e detentori.  
Staffe di supporto Art. 271 e terminali per collettori Art. 298 e 299

FF brass rod manifolds with 3/4" male Euroconus outlets, with thermostatic screw and lockshield valves. Manifold's brackets Art. 271 and terminal parts for manifolds Art. 298 and 299

Colectores HH con empalmes 3/4" M eurocono con valvulas de regulacion termostaticables y detentores. Soportes Art. 271 y tapones terminales Art. 298 y 299

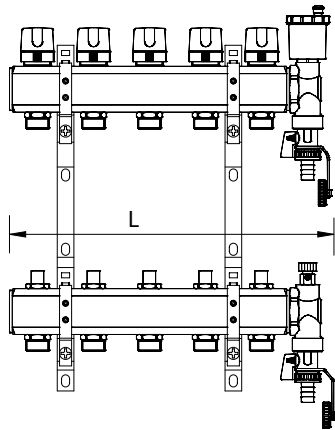

**C332÷C3402**

Code	Version	Size (D)	Smooth	€	D1	H	I	L	Pack
C332060500		1" x 3/4	●	<b>84,39</b>	-	-	50	154	1
C332070500		1" 1/4 x 3/4	●	<b>106,78</b>	-	-	50	154	1
<b>2 vie - 2 ways - 2 vías</b>									
C333060500		1" x 3/4	●	<b>115,74</b>	-	-	50	204	1
C333070500		1" 1/4 x 3/4	●	<b>132,70</b>	-	-	50	204	1
<b>3 vie - 3 ways - 3 vías</b>									
C334060500		1" x 3/4	●	<b>137,90</b>	-	-	50	254	1
C334070500		1" 1/4 x 3/4	●	<b>159,70</b>	-	-	50	254	1
<b>4 vie - 4 ways - 4 vías</b>									
C335060500		1" x 3/4	●	<b>159,36</b>	-	-	50	304	1
C335070500		1" 1/4 x 3/4	●	<b>181,14</b>	-	-	50	304	1
<b>5 vie - 5 ways - 5 vías</b>									
C336060500		1" x 3/4	●	<b>179,79</b>	-	-	50	354	1
C336070500		1" 1/4 x 3/4	●	<b>206,78</b>	-	-	50	354	1
<b>6 vie - 6 ways - 6 vías</b>									
C337060500		1" x 3/4	●	<b>200,99</b>	-	-	50	404	1
C337070500		1" 1/4 x 3/4	●	<b>229,91</b>	-	-	50	404	1
<b>7 vie - 7 ways - 7 vías</b>									
C338060500		1" x 3/4	●	<b>222,07</b>	-	-	50	454	1
C338070500		1" 1/4 x 3/4	●	<b>257,67</b>	-	-	50	454	1
<b>8 vie - 8 ways - 8 vías</b>									
C339060500		1" x 3/4	●	<b>243,81</b>	-	-	50	504	1
C339070500		1" 1/4 x 3/4	●	<b>288,37</b>	-	-	50	504	1
<b>9 vie - 9 ways - 9 vías</b>									
C340060500		1" x 3/4	●	<b>265,13</b>	-	-	50	554	1
C340070500		1" 1/4 x 3/4	●	<b>316,57</b>	-	-	50	554	1
<b>10 vie - 10 ways - 10 vías</b>									
C340160500		1" x 3/4	●	<b>288,00</b>	-	-	50	604	1
C340170500		1" 1/4 x 3/4	●	<b>340,92</b>	-	-	50	604	1
<b>11 vie - 11 ways - 11 vías</b>									
C340260500		1" x 3/4	●	<b>308,24</b>	-	-	50	654	1
C340270500		1" 1/4 x 3/4	●	<b>366,65</b>	-	-	50	654	1
<b>12 vie - 12 ways - 12 vías</b>									



Collettori da barra FF con attacchi 3/4" M eurocono con vitone termostatico e regolatori di flusso. Staffe di supporto Art. 271 e terminali per collettori Art. 298 e 299

*FF brass rod manifolds with 3/4" male Euroconus outlets, with thermostatic screw and flow meters. Manifold's brackets Art. 271 and terminal parts for manifolds Art. 298 and 299*

*Colectores HH con empalmes 3/4" M eurocono con valvulas de regulacion termostaticas y fluxometro. Soportes Art. 271 y tapones terminales Art. 298 y 299*

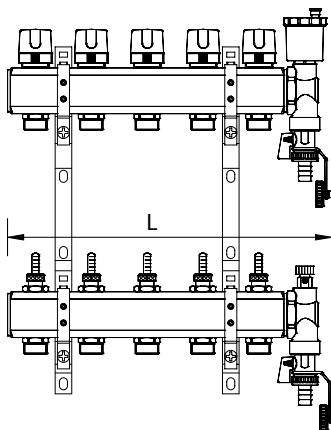

### C342÷C3502

Code	Version	Size (D)	Smooth	€	D1	H	I	L	Pack
C342060500		1"x3/4	●	<b>101,36</b>	-	-	50	154	1
C342070500		1" 1/4x3/4	●	<b>118,43</b>	-	-	50	154	1
<b>2 vie - 2 ways - 2 vías</b>									
C343060500		1"x3/4	●	<b>137,38</b>	-	-	50	204	1
C343070500		1" 1/4x3/4	●	<b>151,80</b>	-	-	50	204	1
<b>3 vie - 3 ways - 3 vías</b>									
C344060500		1"x3/4	●	<b>163,91</b>	-	-	50	254	1
C344070500		1" 1/4x3/4	●	<b>187,37</b>	-	-	50	254	1
<b>4 vie - 4 ways - 4 vías</b>									
C345060500		1"x3/4	●	<b>196,82</b>	-	-	50	304	1
C345070500		1" 1/4x3/4	●	<b>219,16</b>	-	-	50	304	1
<b>5 vie - 5 ways - 5 vías</b>									
C346060500		1"x3/4	●	<b>224,96</b>	-	-	50	354	1
C346070500		1" 1/4x3/4	●	<b>246,28</b>	-	-	50	354	1
<b>6 vie - 6 ways - 6 vías</b>									
C347060500		1"x3/4	●	<b>255,32</b>	-	-	50	404	1
C347070500		1" 1/4x3/4	●	<b>278,38</b>	-	-	50	404	1
<b>7 vie - 7 ways - 7 vías</b>									
C348060500		1"x3/4	●	<b>285,16</b>	-	-	50	454	1
C348070500		1" 1/4x3/4	●	<b>310,97</b>	-	-	50	454	1
<b>8 vie - 8 ways - 8 vías</b>									
C349060500		1"x3/4	●	<b>313,93</b>	-	-	50	504	1
C349070500		1" 1/4x3/4	●	<b>349,61</b>	-	-	50	504	1
<b>9 vie - 9 ways - 9 vías</b>									
C350060500		1"x3/4	●	<b>345,33</b>	-	-	50	554	1
C350070500		1" 1/4x3/4	●	<b>387,50</b>	-	-	50	554	1
<b>10 vie - 10 ways - 10 vías</b>									
C350160500		1"x3/4	●	<b>398,99</b>	-	-	50	604	1
C350170500		1" 1/4x3/4	●	<b>421,94</b>	-	-	50	604	1
<b>11 vie - 11 ways - 11 vías</b>									
C350260500		1"x3/4	●	<b>412,68</b>	-	-	50	654	1
C350270500		1" 1/4x3/4	●	<b>454,73</b>	-	-	50	654	1
<b>12 vie - 12 ways - 12 vías</b>									

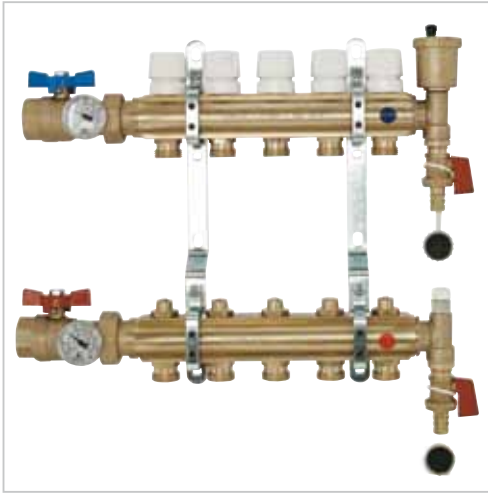

Collettori da barra FF con attacchi 3/4" M eurocono con vitone termostatico e detentori.  
Valvole a sfera con termometro Art. 422M  
Staffe di supporto Art. 271 e terminali per collettori Art. 298 e 299

FF brass rod manifolds with 3/4" male Euroconus outlets, with thermostatic screw and lockshield valves.  
Ball valves with thermometer included Art. 422M  
Manifold's brackets Art. 271 and terminal parts for manifolds Art. 298 and 299

Colectores HH con empalmes 3/4" M eurocono con valvulas de regulacion termostaticas y detentores.  
Valvula de bola con termometro incorporado Art. 422M  
Suportes Art. 271 y tapones terminales Art. 298 y 299

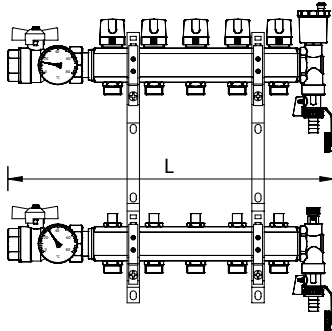

**C332A÷C340A2**

Code	Version	Size (D)	Smooth	€	D1	H	I	L	Pack
C332A60500		1" x 3/4	●	<b>134,84</b>	-	-	50	250	1
C332A70500		1" 1/4 x 3/4	●	<b>155,95</b>	-	-	50	296	1
<b>2 vie - 2 ways - 2 vías</b>									
C333A60500		1" x 3/4	●	<b>164,58</b>	-	-	50	300	1
C333A70500		1" 1/4 x 3/4	●	<b>179,93</b>	-	-	50	346	1
<b>3 vie - 3 ways - 3 vías</b>									
C334A60500		1" x 3/4	●	<b>187,62</b>	-	-	50	350	1
C334A70500		1" 1/4 x 3/4	●	<b>215,89</b>	-	-	50	396	1
<b>4 vie - 4 ways - 4 vías</b>									
C335A60500		1" x 3/4	●	<b>210,02</b>	-	-	50	400	1
C335A70500		1" 1/4 x 3/4	●	<b>227,89</b>	-	-	50	446	1
<b>5 vie - 5 ways - 5 vías</b>									
C336A60500		1" x 3/4	●	<b>229,00</b>	-	-	50	450	1
C336A70500		1" 1/4 x 3/4	●	<b>259,79</b>	-	-	50	496	1
<b>6 vie - 6 ways - 6 vías</b>									
C337A60500		1" x 3/4	●	<b>252,64</b>	-	-	50	500	1
C337A70500		1" 1/4 x 3/4	●	<b>282,82</b>	-	-	50	546	1
<b>7 vie - 7 ways - 7 vías</b>									
C338A60500		1" x 3/4	●	<b>274,18</b>	-	-	50	550	1
C338A70500		1" 1/4 x 3/4	●	<b>307,65</b>	-	-	50	596	1
<b>8 vie - 8 ways - 8 vías</b>									
C339A60500		1" x 3/4	●	<b>295,52</b>	-	-	50	600	1
C339A70500		1" 1/4 x 3/4	●	<b>335,95</b>	-	-	50	646	1
<b>9 vie - 9 ways - 9 vías</b>									
C340A60500		1" x 3/4	●	<b>316,41</b>	-	-	50	650	1
C340A70500		1" 1/4 x 3/4	●	<b>364,71</b>	-	-	50	696	1
<b>10 vie - 10 ways - 10 vías</b>									
C340A60501		1" x 3/4	●	<b>341,89</b>	-	-	50	700	1
C340A70501		1" 1/4 x 3/4	●	<b>390,05</b>	-	-	50	746	1
<b>11 vie - 11 ways - 11 vías</b>									
C340A60502		1" x 3/4	●	<b>366,57</b>	-	-	50	750	1
C340A70502		1" 1/4 x 3/4	●	<b>415,79</b>	-	-	50	796	1
<b>12 vie - 12 ways - 12 vías</b>									





Collettori da barra FF con attacchi 3/4" M eurocono con vitone termostatico e regolatori di flusso a scala graduata. Valvole a sfera con termometro Art. 422M Staffe di supporto Art. 271 e terminali per collettori Art. 298 e 299

*FF brass rod manifolds with 3/4" male Euroconus outlets, with thermostatic screw and flow meters. Ball valves with thermometer included Art. 422M Manifold's brackets Art. 271 and terminal parts for manifolds Art. 298 and 299*

*Colectores de barra HH con empalmes 3/4" M eurocono con valvulas de regulación termostaticables y fluxometro. Válvula de bola con termómetro incorporado Art. 422M Soportes Art. 271 y tapones terminales Art. 298 y 299*

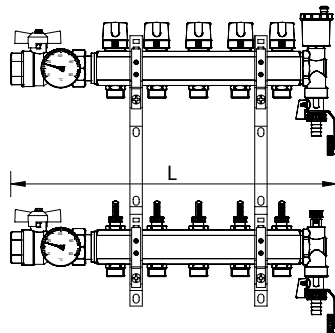

### C342A÷C350A2

Code	Version	Size (D)	Smooth	€	D1	H	I	L	Pack
C342A60500		1"x3/4	●	<b>151,73</b>	-	-	50	250	1
C342A70500		1" 1/4x3/4	●	<b>182,67</b>	-	-	50	296	1
<b>2 vie - 2 ways - 2 vías</b>									
C343A60500		1"x3/4	●	<b>183,90</b>	-	-	50	300	1
C343A70500		1" 1/4x3/4	●	<b>217,66</b>	-	-	50	346	1
<b>3 vie - 3 ways - 3 vías</b>									
C344A60500		1"x3/4	●	<b>210,66</b>	-	-	50	350	1
C344A70500		1" 1/4x3/4	●	<b>253,75</b>	-	-	50	396	1
<b>4 vie - 4 ways - 4 vías</b>									
C345A60500		1"x3/4	●	<b>243,44</b>	-	-	50	400	1
C345A70500		1" 1/4x3/4	●	<b>291,68</b>	-	-	50	446	1
<b>5 vie - 5 ways - 5 vías</b>									
C346A60500		1"x3/4	●	<b>275,54</b>	-	-	50	450	1
C346A70500		1" 1/4x3/4	●	<b>322,53</b>	-	-	50	496	1
<b>6 vie - 6 ways - 6 vías</b>									
C347A60500		1"x3/4	●	<b>300,77</b>	-	-	50	500	1
C347A70500		1" 1/4x3/4	●	<b>355,98</b>	-	-	50	546	1
<b>7 vie - 7 ways - 7 vías</b>									
C348A60500		1"x3/4	●	<b>329,14</b>	-	-	50	550	1
C348A70500		1" 1/4x3/4	●	<b>387,09</b>	-	-	50	596	1
<b>8 vie - 8 ways - 8 vías</b>									
C349A60500		1"x3/4	●	<b>356,07</b>	-	-	50	600	1
C349A70500		1" 1/4x3/4	●	<b>425,71</b>	-	-	50	646	1
<b>9 vie - 9 ways - 9 vías</b>									
C350A60500		1"x3/4	●	<b>385,09</b>	-	-	50	650	1
C350A70500		1" 1/4x3/4	●	<b>463,90</b>	-	-	50	696	1
<b>10 vie - 10 ways - 10 vías</b>									
C350A60501		1"x3/4	●	<b>421,36</b>	-	-	50	700	1
C350A70501		1" 1/4x3/4	●	<b>498,32</b>	-	-	50	746	1
<b>11 vie - 11 ways - 11 vías</b>									
C350A60502		1"x3/4	●	<b>454,51</b>	-	-	50	750	1
C350A70502		1" 1/4x3/4	●	<b>534,93</b>	-	-	50	796	1
<b>12 vie - 12 ways - 12 vías</b>									

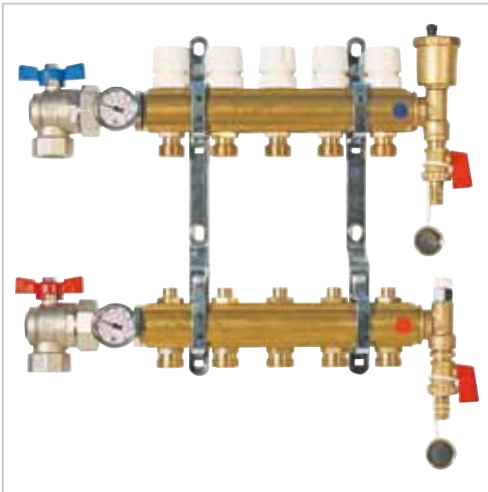

Collettori da barra FF con attacchi 3/4" M eurocono con vitone termostatico e detentori. Valvole a sfera ad angolo Art. 422RM  
Staffe di supporto Art. 271 e terminali per collettori Art. 298 e 299

FF brass rod manifolds with 3/4" male Euroconus outlets, with thermostatic screw and lockshield valves. Angle ball valves Art. 422RM  
Manifold's brackets Art. 271 and terminal parts for manifolds Art. 298 and 299

Colectores HH con empalmes 3/4" M eurocono con valvulas de regulacion termostaticas y detentores. Válvula de bola acodada Art. 422RM  
Suportes Art. 271 y tapones terminales Art. 298 y 299

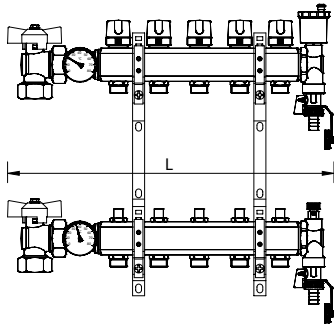

**C332R÷C340R2**

Code	Version	Size (D)	Smooth	€	D1	H	I	L	Pack
C332R60500		1"x3/4	●	<b>135,26</b>	-	-	50	250	1
2 vie - 2 ways - 2 vías									
C333R60500		1"x3/4	●	<b>171,33</b>	-	-	50	300	1
3 vie - 3 ways - 3 vías									
C334R60500		1"x3/4	●	<b>192,83</b>	-	-	50	350	1
4 vie - 4 ways - 4 vías									
C335R60500		1"x3/4	●	<b>215,19</b>	-	-	50	400	1
5 vie - 5 ways - 5 vías									
C336R60500		1"x3/4	●	<b>235,72</b>	-	-	50	450	1
6 vie - 6 ways - 6 vías									
C337R60500		1"x3/4	●	<b>257,15</b>	-	-	50	500	1
7 vie - 7 ways - 7 vías									
C338R60500		1"x3/4	●	<b>278,46</b>	-	-	50	550	1
8 vie - 8 ways - 8 vías									
C339R60500		1"x3/4	●	<b>300,96</b>	-	-	50	600	1
9 vie - 9 ways - 9 vías									
C340R60500		1"x3/4	●	<b>321,67</b>	-	-	50	650	1
10 vie - 10 ways - 10 vías									
C340R60501		1"x3/4	●	<b>347,09</b>	-	-	50	700	1
11 vie - 11 ways - 11 vías									
C340R60502		1"x3/4	●	<b>371,77</b>	-	-	50	750	1
12 vie - 12 ways - 12 vías									



Collettori da barra FF con attacchi 3/4" M eurocono con vitone termostatico e regolatori di flusso a scala graduata.

Valvole a sfera ad angolo Art. 422RM

Staffe di supporto Art. 271 e terminali per collettori Art. 298 e 299

*FF brass rod manifolds with 3/4" male Euroconus outlets, with thermostatic screw and flow meters.*

*Angle ball valves Art. 422RM*

*Manifold's brackets Art. 271 and terminal parts for manifolds Art. 298 and 299*

*Colectores HH con empalmes 3/4" M eurocono con valvulas de regulacion termostaticas y detentores.*

*Válvula de bola acodada Art. 422RM*

*Suportes Art. 271 y tapones terminales Art. 298 y 299*

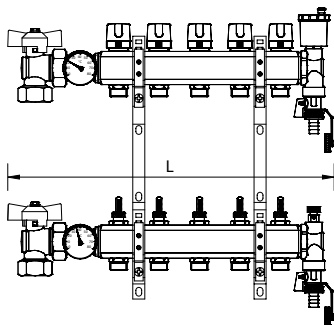

### C342R÷C350R2

Code	Version	Size (D)	Smooth	€	D1	H	I	L	Pack
C342R60500		1"x3/4	●	<b>155,64</b>	-	-	50	250	1
2 vie - 2 ways - 2 vías									
C343R60500		1"x3/4	●	<b>189,25</b>	-	-	50	300	1
3 vie - 3 ways - 3 vías									
C344R60500		1"x3/4	●	<b>215,75</b>	-	-	50	350	1
4 vie - 4 ways - 4 vías									
C345R60500		1"x3/4	●	<b>248,71</b>	-	-	50	400	1
5 vie - 5 ways - 5 vías									
C346R60500		1"x3/4	●	<b>277,22</b>	-	-	50	450	1
6 vie - 6 ways - 6 vías									
C347R60500		1"x3/4	●	<b>304,51</b>	-	-	50	500	1
7 vie - 7 ways - 7 vías									
C348R60500		1"x3/4	●	<b>333,03</b>	-	-	50	550	1
8 vie - 8 ways - 8 vías									
C349R60500		1"x3/4	●	<b>360,95</b>	-	-	50	600	1
9 vie - 9 ways - 9 vías									
C350R60500		1"x3/4	●	<b>388,66</b>	-	-	50	650	1
10 vie - 10 ways - 10 vías									
C350R60501		1"x3/4	●	<b>428,66</b>	-	-	50	700	1
11 vie - 11 ways - 11 vías									
C350R60502		1"x3/4	●	<b>462,19</b>	-	-	50	750	1
12 vie - 12 ways - 12 vías									



Collettori FF in acciaio AISI 304L con uscite 3/4" M Eurocono e detentori di regolazione.

*FF stainless steel AISI 304L manifold with 3/4" M Euroconus outlets and lockshield valves.*

*Colector de acero HH AISI 304L con empalmes 3/4" M Eurocono con detentores.*

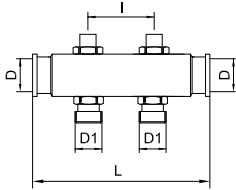

### 332DA÷3402DA

Code	Version	Size (D)	Smooth	€	D1	H	I	L	Pack
332DA60500		1"	●	<b>28,84</b>	3/4	-	50	143	-
2 vie - 2 ways - 2 vías									
333DA60500		1"	●	<b>30,26</b>	3/4	-	50	193	-
3 vie - 3 ways - 3 vías									
334DA60500		1"	●	<b>37,72</b>	3/4	-	50	243	-
4 vie - 4 ways - 4 vías									
335DA60500		1"	●	<b>45,94</b>	3/4	-	50	293	-
5 vie - 5 ways - 5 vías									
336DA60500		1"	●	<b>53,91</b>	3/4	-	50	343	-
6 vie - 6 ways - 6 vías									
337DA60500		1"	●	<b>63,32</b>	3/4	-	50	393	-
7 vie - 7 ways - 7 vías									
338DA60500		1"	●	<b>71,39</b>	3/4	-	50	443	-
8 vie - 8 ways - 8 vías									
339DA60500		1"	●	<b>79,90</b>	3/4	-	50	493	-
9 vie - 9 ways - 9 vías									
340DA60500		1"	●	<b>87,79</b>	3/4	-	50	543	-
10 vie - 10 ways - 10 vías									
3401D6050A		1"	●	<b>96,05</b>	3/4	-	50	593	-
11 vie - 11 ways - 11 vías									
3402D6050A		1"	●	<b>104,66</b>	3/4	-	50	643	-
12 vie - 12 ways - 12 vías									



Collettori FF in acciaio AISI 304L con uscite 3/4" M Eurocono e misuratori di portata.

*FF stainless steel AISI 304L manifold with 3/4" M Euroconus outlets and flow meters.*

*Colector de acero HH AISI 304L con salidas empalmes 3/4" M Eurocono con fluxometro y llave de regulación.*

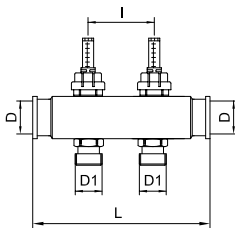

### 332MA÷3402MA

Code	Version	Size (D)	Smooth	€	D1	H	I	L	Pack
332MA60500		1"	●	<b>32,92</b>	3/4	-	50	143	-
2 vie - 2 ways - 2 vías									
333MA60500		1"	●	<b>45,60</b>	3/4	-	50	193	-
3 vie - 3 ways - 3 vías									
334MA60500		1"	●	<b>58,18</b>	3/4	-	50	243	-
4 vie - 4 ways - 4 vías									
335MA60500		1"	●	<b>71,52</b>	3/4	-	50	293	-
5 vie - 5 ways - 5 vías									
336MA60500		1"	●	<b>84,60</b>	3/4	-	50	343	-
6 vie - 6 ways - 6 vías									
337MA60500		1"	●	<b>99,12</b>	3/4	-	50	393	-
7 vie - 7 ways - 7 vías									
338MA60500		1"	●	<b>112,31</b>	3/4	-	50	443	-
8 vie - 8 ways - 8 vías									
339MA60500		1"	●	<b>125,94</b>	3/4	-	50	493	-
9 vie - 9 ways - 9 vías									
340MA60500		1"	●	<b>138,95</b>	3/4	-	50	543	-
10 vie - 10 ways - 10 vías									
3401M6050A		1"	●	<b>152,32</b>	3/4	-	50	593	-
11 vie - 11 ways - 11 vías									
3402M6050A		1"	●	<b>166,05</b>	3/4	-	50	643	-
12 vie - 12 ways - 12 vías									



Collettori FF in acciaio AISI 304L con uscite 3/4" M Eurocono e vitoni termostatici e volantino micrometrico.

*FF stainless steel AISI 304L manifold with 3/4" M Euroconus outlets and thermostatic screws and micrometric wheelhandle.*



*Colector de acero HH AISI 304L con salidas empalmes 3/4" M Eurocono con valvulas termostaticas y capuchon.*

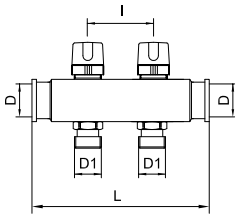

**332TA÷3402TA**

Code	Version	Size (D)	Smooth	€	D1	H	I	L	Pack
332TA60500		1"	●	<b>24,93</b>	3/4	-	50	143	-
2 vie - 2 ways - 2 vías									
333TA60500		1"	●	<b>33,63</b>	3/4	-	50	193	-
3 vie - 3 ways - 3 vías									
334TA60500		1"	●	<b>42,21</b>	3/4	-	50	243	-
4 vie - 4 ways - 4 vías									
335TA60500		1"	●	<b>51,55</b>	3/4	-	50	293	-
5 vie - 5 ways - 5 vías									
336TA60500		1"	●	<b>60,64</b>	3/4	-	50	343	-
6 vie - 6 ways - 6 vías									
337TA60500		1"	●	<b>71,18</b>	3/4	-	50	393	-
7 vie - 7 ways - 7 vías									
338TA60500		1"	●	<b>80,37</b>	3/4	-	50	443	-
8 vie - 8 ways - 8 vías									
339TA60500		1"	●	<b>90,00</b>	3/4	-	50	493	-
9 vie - 9 ways - 9 vías									
340TA60500		1"	●	<b>99,02</b>	3/4	-	50	543	-
10 vie - 10 ways - 10 vías									
3401T6050A		1"	●	<b>108,40</b>	3/4	-	50	593	-
11 vie - 11 ways - 11 vías									
3402T6050A		1"	●	<b>118,14</b>	3/4	-	50	643	-
12 vie - 12 ways - 12 vías									



Collettori FF in acciaio AISI 304L con attacchi 3/4" M Eurocono, con vitoni termostatici e detentori di regolazione. Staffe di supporto Art. 271.

*FF stainless steel AISI 304L with 3/4" male Euroconus outlets, with thermostatic valves and lockshield valves. Manifold's brackets Art. 271.*

*Colectores HH de acero AISI 304L con empalmes 3/4" M Eurocono con valvulas del regulacion termostaticables y detentores. Suportes Art. 271.*

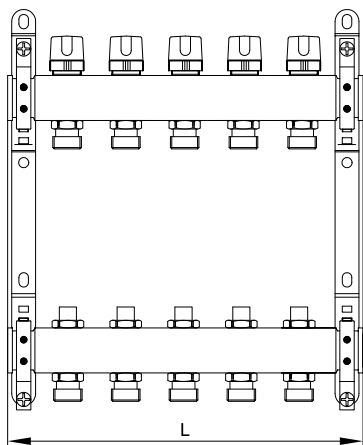

### A312÷A3202

Code	Version	Size (D)	Smooth	€	D1	H	I	L	Pack
A312060500		1"x3/4	●	<b>66,47</b>	-	-	50	143	1
2 vie - 2 ways - 2 vías									
A313060500		1"x3/4	●	<b>80,11</b>	-	-	50	193	1
3 vie - 3 ways - 3 vías									
A314060500		1"x3/4	●	<b>97,58</b>	-	-	50	243	1
4 vie - 4 ways - 4 vías									
A315060500		1"x3/4	●	<b>116,52</b>	-	-	50	293	1
5 vie - 5 ways - 5 vías									
A316060500		1"x3/4	●	<b>135,00</b>	-	-	50	343	1
6 vie - 6 ways - 6 vías									
A317060500		1"x3/4	●	<b>156,32</b>	-	-	50	393	1
7 vie - 7 ways - 7 vías									
A318060500		1"x3/4	●	<b>175,02</b>	-	-	50	443	1
8 vie - 8 ways - 8 vías									
A319060500		1"x3/4	●	<b>194,54</b>	-	-	50	493	1
9 vie - 9 ways - 9 vías									
A320060500		1"x3/4	●	<b>212,97</b>	-	-	50	543	1
10 vie - 10 ways - 10 vías									
A320160500		1"x3/4	●	<b>231,88</b>	-	-	50	593	1
11 vie - 11 ways - 11 vías									
A320260500		1"x3/4	●	<b>251,66</b>	-	-	50	643	1
12 vie - 12 ways - 12 vías									



Collettori FF in acciaio AISI 304L con attacchi 3/4" M Eurocono, con vitoni termostatici e misuratori di portata. Staffe di supporto Art. 271.

FF stainless steel AISI 304L with 3/4" male Euroconus outlets, with thermostatic valves and flow meters. Manifold's brackets Art. 271.

Colectores FF de acero AISI 304L con empalmes 3/4" M Eurocono con valvulas del regulacion termostaticables y fluxometro. Suportes Art. 271.

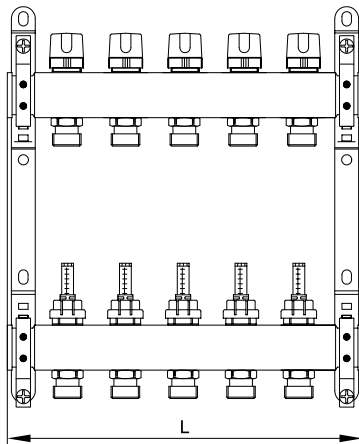

**A322÷A3302**

Code	Version	Size (D)	Smooth	€	D1	H	I	L	Pack
A322060500		1"x3/4	●	<b>73,15</b>	-	-	50	143	1
2 vie - 2 ways - 2 vías									
A323060500		1"x3/4	●	<b>96,13</b>	-	-	50	193	1
3 vie - 3 ways - 3 vías									
A324060500		1"x3/4	●	<b>118,94</b>	-	-	50	243	1
4 vie - 4 ways - 4 vías									
A325060500		1"x3/4	●	<b>143,22</b>	-	-	50	293	1
5 vie - 5 ways - 5 vías									
A326060500		1"x3/4	●	<b>167,03</b>	-	-	50	343	1
6 vie - 6 ways - 6 vías									
A327060500		1"x3/4	●	<b>193,69</b>	-	-	50	393	1
7 vie - 7 ways - 7 vías									
A328060500		1"x3/4	●	<b>217,73</b>	-	-	50	443	1
8 vie - 8 ways - 8 vías									
A329060500		1"x3/4	●	<b>242,58</b>	-	-	50	493	1
9 vie - 9 ways - 9 vías									
A330060500		1"x3/4	●	<b>266,26</b>	-	-	50	543	1
10 vie - 10 ways - 10 vías									
A330160500		1"x3/4	●	<b>290,61</b>	-	-	50	593	1
11 vie - 11 ways - 11 vías									
A330260500		1"x3/4	●	<b>315,68</b>	-	-	50	643	1
12 vie - 12 ways - 12 vías									



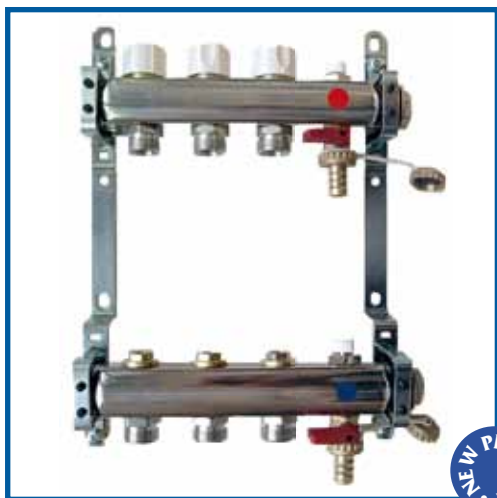

Collettori FF in acciaio AISI 304L con attacchi 3/4" M Eurocono, con vitoni termostatici e detentori di regolazione. Valvola sfiato aria ART. 418CR, rubinetto di scarico ART. 476CS e staffe di supporto Art. 271.

*FF stainless steel AISI 304L with 3/4" male Euroconus outlets, with thermostatic screws and lockshield valves. Air discharge valve ART. 418CR, drain ball valve ART. 476CS and manifold's brackets Art. 271.*

*Colectores HH de acero AISI 304L con empalmes 3/4" M Eurocono con valvula de regulacion termostaticables y detentores. Valvula de desahogo de aire Art. 418CR, llave de bola evacuación caldera Art. 476CS y suportes Art. 271.*

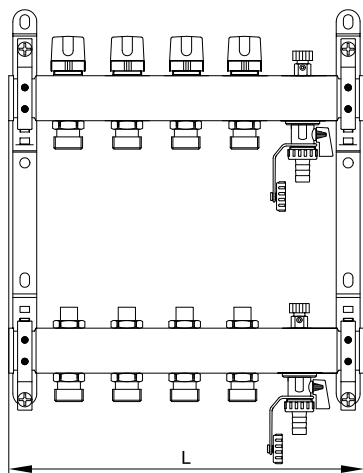

### A332÷A3402

Code	Version	Size (D)	Smooth	€	D1	H	I	L	Pack
A332060500		1"x3/4	●	<b>92,84</b>	-	-	50	143	1
2 vie - 2 ways - 2 vías									
A333060500		1"x3/4	●	<b>108,67</b>	-	-	50	193	1
3 vie - 3 ways - 3 vías									
A334060500		1"x3/4	●	<b>126,01</b>	-	-	50	243	1
4 vie - 4 ways - 4 vías									
A335060500		1"x3/4	●	<b>142,84</b>	-	-	50	293	1
5 vie - 5 ways - 5 vías									
A336060500		1"x3/4	●	<b>162,56</b>	-	-	50	343	1
6 vie - 6 ways - 6 vías									
A337060500		1"x3/4	●	<b>179,61</b>	-	-	50	393	1
7 vie - 7 ways - 7 vías									
A338060500		1"x3/4	●	<b>197,52</b>	-	-	50	443	1
8 vie - 8 ways - 8 vías									
A339060500		1"x3/4	●	<b>214,21</b>	-	-	50	493	1
9 vie - 9 ways - 9 vías									
A340060500		1"x3/4	●	<b>231,62</b>	-	-	50	543	1
10 vie - 10 ways - 10 vías									
A340160500		1"x3/4	●	<b>249,75</b>	-	-	50	593	1
11 vie - 11 ways - 11 vías									
A340260500		1"x3/4	●	<b>274,37</b>	-	-	50	643	1
12 vie - 12 ways - 12 vías									



Collettori FF in acciaio AISI 304L con attacchi 3/4" M Eurocono, con vitoni termostatici e misuratori di portata. Valvola sfiato aria ART. 418CR, rubinetto di scarico ART. 476CS, staffe di supporto Art. 271, tappi 1" Art. 231.

*FF stainless steel AISI 304L with 3/4" male Euroconus outlets, with thermostatic screws and flow meters. Air discharge valve ART. 418CR, drain ball valve ART. 476CS, manifold's brackets Art. 271, taps 1" Art. 231.*

*Colectores HH de acero AISI 304L con empalmes 3/4" M Eurocono con valvula de regulacion termostaticables y fluxometro. Valvula de desahogo de aire cromada ART. 418CR, llave de bola evacuación ART. 476CS, supportes Art. 271, tapón 1" Art. 231.*

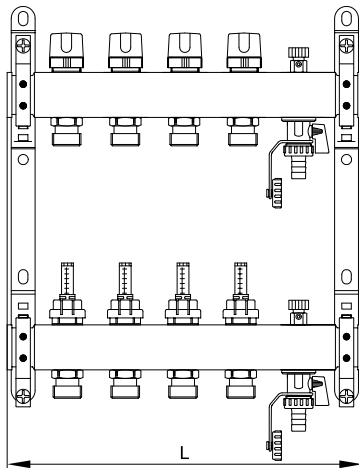

**A342÷A3502**

Code	Version	Size (D)	Smooth	€	D1	H	I	L	Pack
A342060500		1" x 3/4	●	<b>101,87</b>	-	-	50	143	1
2 vie - 2 ways - 2 vías									
A343060500		1" x 3/4	●	<b>123,10</b>	-	-	50	193	1
3 vie - 3 ways - 3 vías									
A344060500		1" x 3/4	●	<b>145,84</b>	-	-	50	243	1
4 vie - 4 ways - 4 vías									
A345060500		1" x 3/4	●	<b>167,12</b>	-	-	50	293	1
5 vie - 5 ways - 5 vías									
A346060500		1" x 3/4	●	<b>193,20</b>	-	-	50	343	1
6 vie - 6 ways - 6 vías									
A347060500		1" x 3/4	●	<b>215,66</b>	-	-	50	393	1
7 vie - 7 ways - 7 vías									
A348060500		1" x 3/4	●	<b>238,98</b>	-	-	50	443	1
8 vie - 8 ways - 8 vías									
A349060500		1" x 3/4	●	<b>261,07</b>	-	-	50	493	1
9 vie - 9 ways - 9 vías									
A350060500		1" x 3/4	●	<b>283,89</b>	-	-	50	543	1
10 vie - 10 ways - 10 vías									
A350160500		1" x 3/4	●	<b>307,43</b>	-	-	50	593	1
11 vie - 11 ways - 11 vías									
A350260500		1" x 3/4	●	<b>337,45</b>	-	-	50	643	1
12 vie - 12 ways - 12 vías									



Collettori FF in acciaio AISI 304L con attacchi 3/4" M Eurocono, con vitoni termostatici e detentori di regolazione. Staffe di supporto Art. 271 e terminali per collettori Art. 2980N e Art. 2990N.

*FF stainless steel AISI 304L with 3/4" male Euroconus outlets, with thermostatic screws and lockshield valves. Manifold's brackets Art. 271 and terminal parts for manifolds Art. 2980N and 2990N.*

*Colectores HH de acero AISI 304L con empalmes 3/4" M Eurocono con valvula de regulacion termostaticables y detentores. Soportes Art. 271 y tapones terminales Art. 2980N y 2990N.*

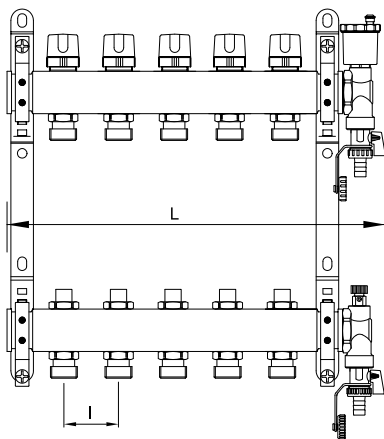

### A332A÷A3402A

Code	Version	Size (D)	Smooth	€	D1	H	I	L	Pack
A33206050A		1"x3/4	●	<b>94,98</b>	-	-	50	195	1
2 vie - 2 ways - 2 vías									
A33306050A		1"x3/4	●	<b>111,02</b>	-	-	50	245	1
3 vie - 3 ways - 3 vías									
A33406050A		1"x3/4	●	<b>127,84</b>	-	-	50	295	1
4 vie - 4 ways - 4 vías									
A33506050A		1"x3/4	●	<b>144,18</b>	-	-	50	345	1
5 vie - 5 ways - 5 vías									
A33606050A		1"x3/4	●	<b>164,01</b>	-	-	50	395	1
6 vie - 6 ways - 6 vías									
A33706050A		1"x3/4	●	<b>181,73</b>	-	-	50	445	1
7 vie - 7 ways - 7 vías									
A33806050A		1"x3/4	●	<b>199,18</b>	-	-	50	495	1
8 vie - 8 ways - 8 vías									
A33906050A		1"x3/4	●	<b>215,70</b>	-	-	50	545	1
9 vie - 9 ways - 9 vías									
A34006050A		1"x3/4	●	<b>233,38</b>	-	-	50	595	1
10 vie - 10 ways - 10 vías									
A34016050A		1"x3/4	●	<b>251,19</b>	-	-	50	645	1
11 vie - 11 ways - 11 vías									
A34026050A		1"x3/4	●	<b>275,93</b>	-	-	50	695	1
12 vie - 12 ways - 12 vías									



Collettori FF in acciaio AISI 304L con attacchi 3/4" M Eurocono, con vitoni termostatici e misuratori di portata. Staffe di supporto Art. 271 e terminali per collettori Art. 2980N e 2990N.

*FF stainless steel AISI 304L with 3/4" male Euroconus outlets, with thermostatic screws and flow meters. Manifold's brackets Art. 271 and terminal parts for manifolds ART. 2980N and 2990N.*

*Colectores HH de acero AISI 304L con empalmes 3/4" M Eurocono con valvola de regulacion termostaticables y fluxometro. Soportes Art. 271 y tapones terminales Art. 2980N y 2990N.*

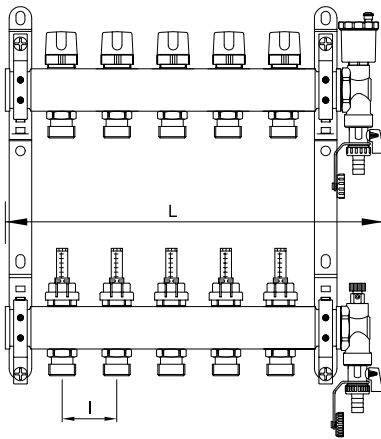

**A342A÷A3502A**

Code	Version	Size (D)	Smooth	€	D1	H	I	L	Pack
A34206050A		1"x3/4	●	<b>104,00</b>	-	-	50	195	1
2 vie - 2 ways - 2 vías									
A34306050A		1"x3/4	●	<b>125,45</b>	-	-	50	245	1
3 vie - 3 ways - 3 vías									
A34406050A		1"x3/4	●	<b>147,68</b>	-	-	50	295	1
4 vie - 4 ways - 4 vías									
A34506050A		1"x3/4	●	<b>169,46</b>	-	-	50	345	1
5 vie - 5 ways - 5 vías									
A34606050A		1"x3/4	●	<b>195,66</b>	-	-	50	395	1
6 vie - 6 ways - 6 vías									
A34706050A		1"x3/4	●	<b>217,78</b>	-	-	50	445	1
7 vie - 7 ways - 7 vías									
A34806050A		1"x3/4	●	<b>240,24</b>	-	-	50	495	1
8 vie - 8 ways - 8 vías									
A34906050A		1"x3/4	●	<b>263,56</b>	-	-	50	545	1
9 vie - 9 ways - 9 vías									
A35006050A		1"x3/4	●	<b>285,65</b>	-	-	50	595	1
10 vie - 10 ways - 10 vías									
A35016050A		1"x3/4	●	<b>309,47</b>	-	-	50	645	1
11 vie - 11 ways - 11 vías									
A35026050A		1"x3/4	●	<b>339,01</b>	-	-	50	695	1
12 vie - 12 ways - 12 vías									



Collettori FF in acciaio AISI 304L con attacchi 3/4" M Eurocono, con vitoni termostatici e detentori. Valvole a sfera con termometro Art. 422M, staffe di supporto ART. 271 e terminali per collettori ART. 2980N e ART. 2990N.

FF stainless steel AISI 304L with 3/4" male Euroconus outlets, with thermostatic screws and lockshield valves. Ball valves thermometer included Art. 422M, manifold's brackets ART. 271 and terminal parts for manifolds ART. 2980N and 2990N.

Colectores HH de acero AISI 304L con empalmes 3/4" M Eurocono con valvula de regulacion termostaticables y detentores. Valvula de bola con termometro incorporado Art. 422M, suportes Art. 271 y tapones terminales Art. 2980N y 2990N.

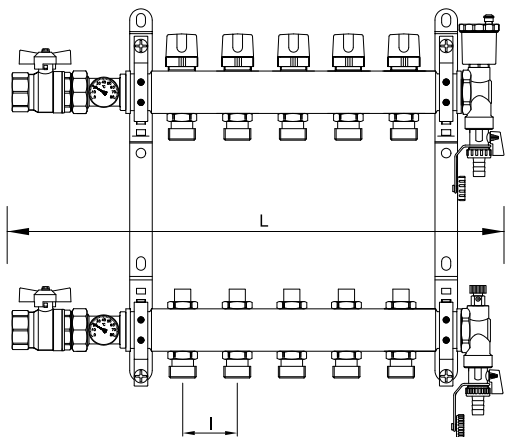

**A332AA÷A3402AA**

Code	Version	Size (D)	Smooth	€	D1	H	I	L	Pack
A332A6050A		1"x3/4	●	<b>139,39</b>	-	-	50	291	1
2 vie - 2 ways - 2 vías									
A333A6050A		1"x3/4	●	<b>155,43</b>	-	-	50	341	1
3 vie - 3 ways - 3 vías									
A334A6050A		1"x3/4	●	<b>171,26</b>	-	-	50	391	1
4 vie - 4 ways - 4 vías									
A335A6050A		1"x3/4	●	<b>188,60</b>	-	-	50	441	1
5 vie - 5 ways - 5 vías									
A336A6050A		1"x3/4	●	<b>205,43</b>	-	-	50	491	1
6 vie - 6 ways - 6 vías									
A337A6050A		1"x3/4	●	<b>225,15</b>	-	-	50	541	1
7 vie - 7 ways - 7 vías									
A338A6050A		1"x3/4	●	<b>242,20</b>	-	-	50	591	1
8 vie - 8 ways - 8 vías									
A339A6050A		1"x3/4	●	<b>260,11</b>	-	-	50	641	1
9 vie - 9 ways - 9 vías									
A340A6050A		1"x3/4	●	<b>276,80</b>	-	-	50	691	1
10 vie - 10 ways - 10 vías									
A340A6150A		1"x3/4	●	<b>294,21</b>	-	-	50	741	1
11 vie - 11 ways - 11 vías									
A340A6250A		1"x3/4	●	<b>312,34</b>	-	-	50	791	1
12 vie - 12 ways - 12 vías									



Collettori FF in acciaio AISI 304L con attacchi 3/4" M Eurocono, con vitoni termostatici e misuratori di portata. Valvole a sfera con termometro ART. 422M, staffe di supporto ART. 271 e terminali per collettore ART. 2980N e ART. 2990N.

*FF stainless steel AISI 304L with 3/4" male Euroconus outlets, with thermostatic screw and flow meters. Ball valves with thermometer included ART. 422M, manifold's brackets ART. 271 and terminal parts for manifolds ART. 2980N and 2990N.*

*Colectores HH de acero AISI 304L con empalmes 3/4" M Eurocono con valvulas de regulacion termostaticables y fluxometro. Válvula de bola con termómetro incorporado Art. 422M, soportes Art. 271 y tapones terminales Art. 2980N y 2990N.*

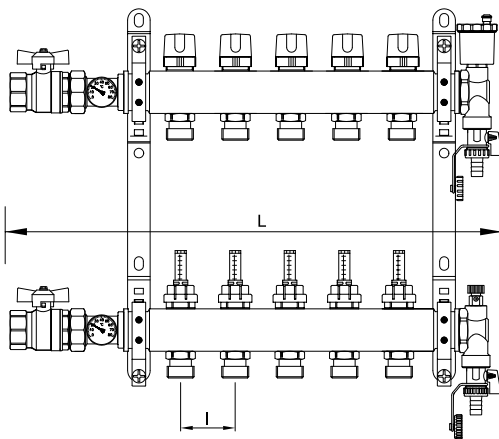

**A342AA÷A3502AA**

Code	Version	Size (D)	Smooth	€	D1	H	I	L	Pack
A342A6050A		1"x3/4	●	<b>148,42</b>	-	-	50	291	1
2 vie - 2 ways - 2 vías									
A343A6050A		1"x3/4	●	<b>169,86</b>	-	-	50	341	1
3 vie - 3 ways - 3 vías									
A344A6050A		1"x3/4	●	<b>191,09</b>	-	-	50	391	1
4 vie - 4 ways - 4 vías									
A345A6050A		1"x3/4	●	<b>212,88</b>	-	-	50	441	1
5 vie - 5 ways - 5 vías									
A346A6050A		1"x3/4	●	<b>236,08</b>	-	-	50	491	1
6 vie - 6 ways - 6 vías									
A347A6050A		1"x3/4	●	<b>261,20</b>	-	-	50	541	1
7 vie - 7 ways - 7 vías									
A348A6050A		1"x3/4	●	<b>283,65</b>	-	-	50	591	1
8 vie - 8 ways - 8 vías									
A349A6050A		1"x3/4	●	<b>306,97</b>	-	-	50	641	1
9 vie - 9 ways - 9 vías									
A350A6050A		1"x3/4	●	<b>329,07</b>	-	-	50	691	1
10 vie - 10 ways - 10 vías									
A350A6150A		1"x3/4	●	<b>351,89</b>	-	-	50	741	1
11 vie - 11 ways - 11 vías									
A350A6250A		1"x3/4	●	<b>375,42</b>	-	-	50	791	1
12 vie - 12 ways - 12 vías									



### C301

Code	Version	Size (D)	Smooth	€	D1	H	I	L	Pack
C301000D00		-		<b>210,49</b>	-	-	-	-	1

Kit regolazione termica a punto fisso per pannelli radianti  
*Fixed point regulating kit for radiant panels*  
*Kit de regulaciòn con punto fijo para paneles radiantes*



### C307K

Code	Version	Size (D)	Smooth	€	D1	H	I	L	Pack
C307K00000		1"		<b>159,88</b>	-	130	-	157	1

Kit premontato a punto fisso per bassa temperatura  
*Fixed point regulation kit low temperature*  
*Kit premontado con punto fijo para baja temperatura*



### C307KA

Code	Version	Size (D)	Smooth	€	D1	H	I	L	Pack
C307KA2000		1"		<b>163,81</b>	-	130	-	255	1

2 vie - 2 ways - 2 vías

C307KA3000		1"		<b>167,69</b>	-	130	-	305	1
------------	--	----	--	---------------	---	-----	---	-----	---

3 vie - 3 ways - 3 vías

Kit premontato a punto fisso per alta-bassa e bassa temperatura  
*Fixed point regulation kit low and high temperature*  
*Kit premontado con punto fijo para alta-baja y baja temperatura*



### C308KB

Code	Version	Size (D)	Smooth	€	D1	H	I	L	Pack
C308KB0000		-		<b>14,35</b>	-	-	-	-	1

Kit by-pass eccentric  
*Off-centre by-pass kit*  
*Kit by-pass excentrico*

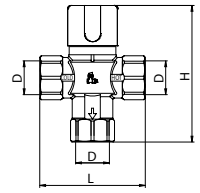

**650**

Code	Version	Size (D)	Smooth	€	D1	H	I	L	Pack
6500N00400		1/2	●	<b>44,11</b>	-	115	-	78	1
6500N00500		3/4	●	<b>44,11</b>	-	115	-	78	1
6500N00600		1"	●	<b>45,70</b>	-	115	-	90	1

Prodotto in ottone a basso contenuto di piombo *Low-lead brass*

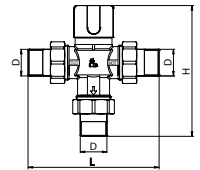

**652**

Code	Version	Size (D)	Smooth	€	D1	H	I	L	Pack
6520N00500		3/4	●	<b>50,35</b>	-	138	-	135	1
6520N00600		1"	●	<b>54,65</b>	-	146	-	153	1

Prodotto in ottone a basso contenuto di piombo *Low-lead brass*

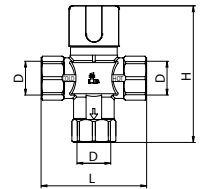

**653**

Code	Version	Size (D)	Smooth	€	D1	H	I	L	Pack
6530N00400		1/2	●	<b>46,83</b>	-	115	-	78	1
6530N00500		3/4	●	<b>46,83</b>	-	115	-	78	1
6530N00600		1"	●	<b>48,80</b>	-	115	-	90	1

Prodotto in ottone a basso contenuto di piombo *Low-lead brass*

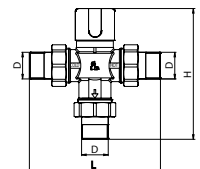

**654**

Code	Version	Size (D)	Smooth	€	D1	H	I	L	Pack
6540N00500		3/4	●	<b>56,11</b>	-	138	-	135	1
6540N00600		1"	●	<b>57,44</b>	-	146	-	153	1

Prodotto in ottone a basso contenuto di piombo *Low-lead brass*



Valvola miscelatrice  
termostatica a 3 vie  
*3 ways thermostatic  
mixing valve*  
*Válvula mezcladora  
termostática 3 vías*



Valvola miscelatrice  
termostatica a 3 vie  
con attacco maschio  
*3 ways thermostatic  
mixing valve with  
male connection*  
*Válvula mezcladora  
termostática 3 vías  
con empalmes macho*



Valvola miscelatrice  
termostatica a 3 vie  
per impianti solari  
*3 ways thermostatic  
mixing valve solar systems*  
*Válvula mezcladora  
termostática 3 vías  
para sistemas de solares*



Valvola miscelatrice  
termostatica a 3 vie  
per impianti solari  
con attacco maschio  
*3 ways thermostatic  
mixing valve solar systems,  
with male connection*  
*Válvula mezcladora  
termostática 3 vías  
para sistemas de solares  
con empalmes macho*



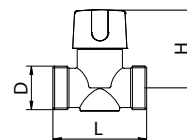

### 662

Code	Version	Size (D)	Smooth	€	D1	H	h	l	L	M	Pack
662V000400		1/2	●	<b>11,47</b>	-	48	-	-	53	-	4
662V000500		3/4	●	<b>11,64</b>	-	48	-	-	56	-	4
662V000600		1"	●	<b>15,42</b>	-	52	-	-	65	-	4

Valvola a 2 vie per Fan Coil  
2 ways Fan Coil valve  
Válvula de 2 vías para Fan Coil

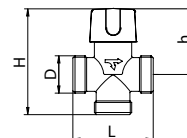

### 663

Code	Version	Size (D)	Smooth	€	D1	H	h	l	L	M	Pack
663V000400		1/2	●	<b>19,25</b>	-	78	48	-	53	-	4
663V000500		3/4	●	<b>19,72</b>	-	76	48	-	56	-	4
663V000600		1"	●	<b>22,16</b>	-	87	52	-	65	-	4

Valvola a 3 vie per Fan Coil  
3 ways Fan Coil valve  
Válvula de 3 vías para Fan Coil

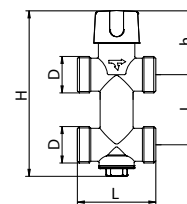

### 664

Code	Version	Size (D)	Smooth	€	D1	H	h	l	L	M	Pack
664V000400		1/2	●	<b>24,94</b>	-	102	48	36	53	-	4
664V000500		3/4	●	<b>25,45</b>	-	116	48	50	56	-	4
664V000600		1"	●	<b>28,74</b>	-	124	52	50	65	-	4

Valvola a 4 vie per Fan Coil  
4 ways Fan Coil valve  
Válvula de 4 vías para Fan Coil



Scelta delle dimensioni della cassetta Art. 269 in relazione al numero delle derivazioni dei collettori

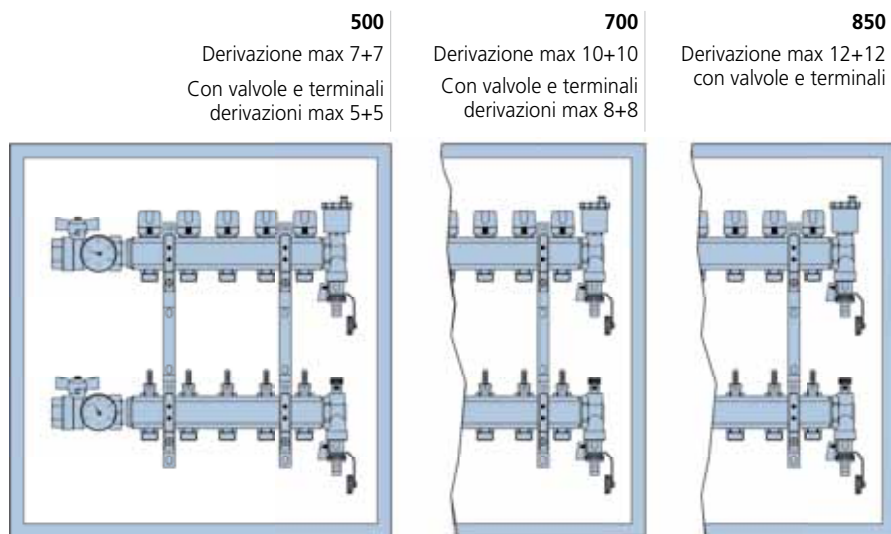

Scelta delle dimensioni della cassetta Art. 270 in relazione al numero delle derivazioni dei collettori

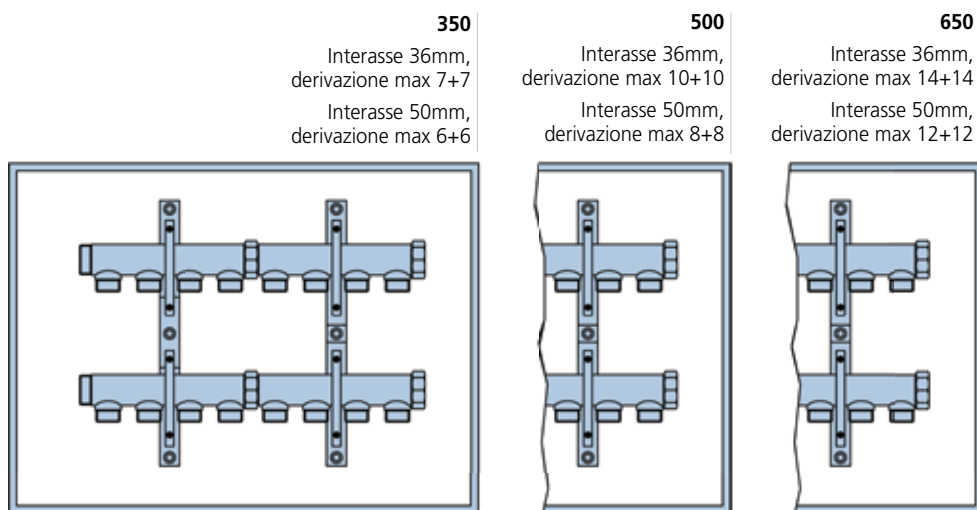

Art. 650 - 652 - 652S Diagramma delle perdite di carico per valvole miscelatrici 1/2" - 3/4" - 1"

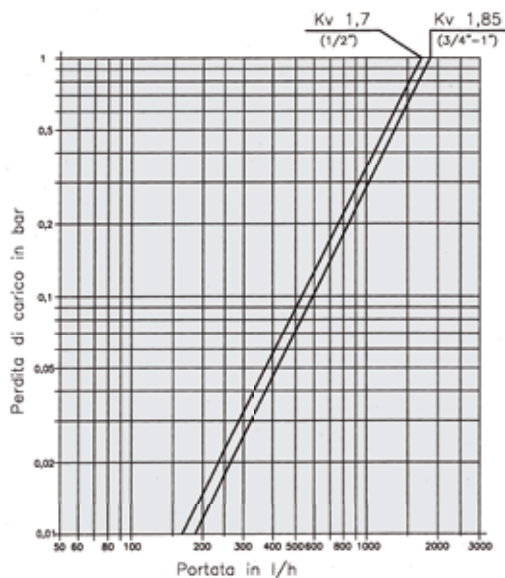



**210**

Dado con bicono in P.T.F.E.  
*Brass nut and P.T.F.E. ring*  
*Tuerca con bicono de P.T.F.E.*  
Ø 10 - 12 - 14 - 15 - 16

**210G**

Dado con bicono in gomma  
*Brass nut and rubber ring*  
*Tuerca con bicono de goma*  
Ø 10 - 12 - 14 - 15 - 16

**219**

Adattatore per tubo multistrato  
*Multilayer tube adaptor*  
*Adaptador para tubo multicapa*  
Ø 14x2 - 16x2  
Ø 16x2,25 - 16x1,8

**220**

Adattatore per tubo di plastica  
*Plastic tube adaptor*  
*Adaptador para tubo de plástico*  
Ø 12x2 - 15x2,5 - 14x2 - 16x1,8  
Ø 16x2 - 16x2,2

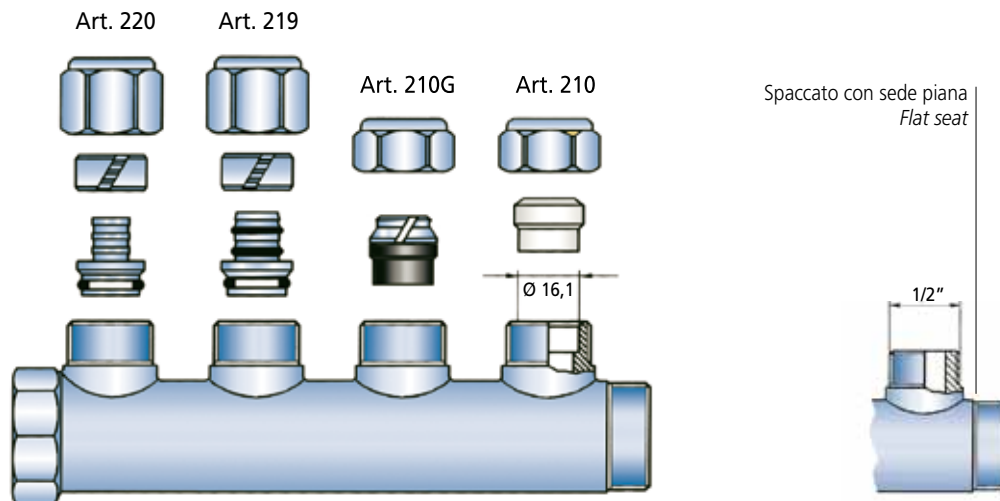

**210E**

Dado con bicono in gomma, Eurocono  
*Euroconus brass nut and rubber ring*  
*Tuerca con bicono de goma, Eurocono*  
Ø 10x3/4 - 12x3/4 - 14x3/4 - 15x3/4 - 16x3/4 - 18x3/4

**219E**

Adattatore per tubo multistrato tipo Eurocono  
*Multilayer tube adaptor Euroconus type*  
*Adaptador para tubo multicapa tipo Eurocono*  
Ø 14x2x3/4 - 16x1,8x3/4 - 16x2x3/4 - 16x2,25x3/4 - 17x2x3/4  
Ø 18x2x3/4 - 20x2x3/4 - 20x2,5x3/4 - 20x2,25x3/4

**220E**

Adattatore per tubo di plastica tipo Eurocono  
*Plastic tube adaptor Euroconus type*  
*Adaptador para tubo de plástico tipo Eurocono*  
Ø 12x2x3/4 - 14x2x3/4 - 15x2,5x3/4 - 16x1,8x3/4 - 16x2x3/4  
Ø 16x2,25x3/4 - 17x2x3/4 - 18x2x3/4 - 20x1,8x3/4 - 20x2x3/4  
Ø 20x2,25x3/4 - 22x2,5x3/4

**214X**

Dado con bicono in gomma 24x19  
*24x19 brass nut and rubber ring*  
*Tuerca con tubo de goma 24x19*  
Ø 14 - 15 - 16 - 18

**219X**

Adattatore per tubo multistrato 24x19  
*Multilayer 24x19 tube adaptor*  
*Adaptador para tubo multicapa 24x19*  
Ø 16x2 - 18x2 - 18x2,5

**220X**

Adattatore per tubo PVC 24x19  
*Plastic 24x19 tube PVC adaptor*  
*Adaptador para tubo PVC 24x19*  
Ø 15x2,5 - 16x2 - 18x2 - 18x2,5

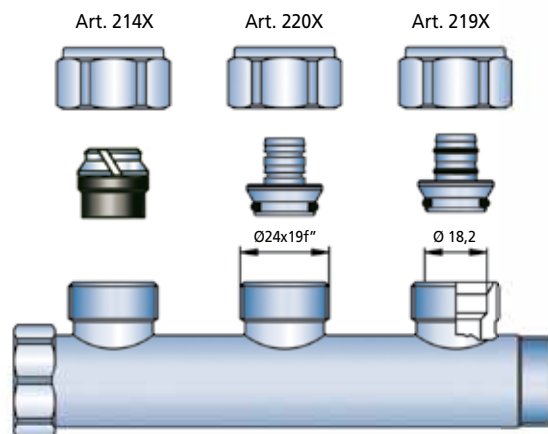
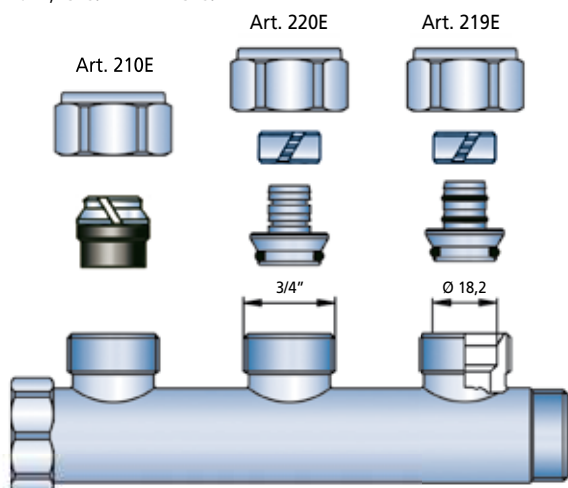



**BIANCHI F.lli S.p.a.**  
Rubinetteria

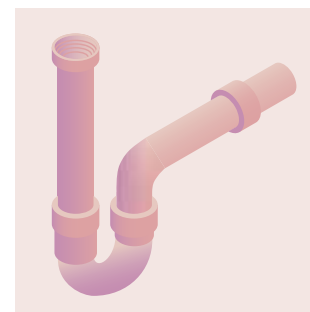
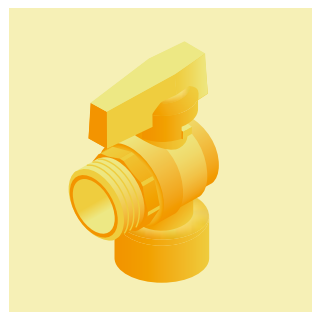
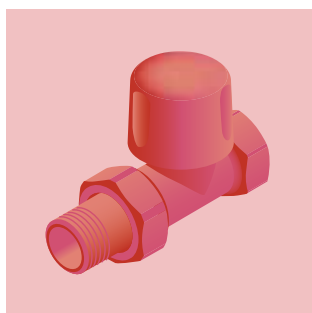
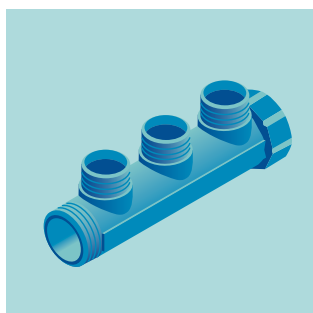

---

MADE IN ITALY  
[www.bianchifratelli.it](http://www.bianchifratelli.it)