

VALVOLE PER RADIATORI

Radiator Valves

CARATTERISTICHE TECNICO/COSTRUTTIVE GENERALI

- **Materiali**

- Corpo, dado e codolo: ottone UNI EN 12165-CW617N stampato a caldo
- Asta di manovra, otturatore e premistoppa: ottone UNI EN 12164-CW614N tornito
- Guarnizioni: NBR, EPDM, PTFE puro
- Volantino o cappuccio: ABS antiurto, colore bianco

- Finitura: nichelata, cromata o gialla

- Disponibile nei modelli ad angolo e diritto. Misura, secondo la serie, da 3/8" a 3/4"

- Tipi di filettature: ISO 228

- Caratteristiche fluidodinamiche secondo il diagramma "Portata/Perdita di carico"

- Durante le lavorazioni tutti i particolari sono controllati secondo modalità definite nelle procedure del sistema qualità aziendale, certificato secondo la norma UNI EN ISO 9001:2008

Le caratteristiche e le misure sono indicative e non impegnano la BIANCHI F.LLI, che si riserva il diritto di apportare ai propri articoli, in qualunque momento e senza preavviso, modifiche tecniche o commerciali.



BIANCHI F.LLI S.p.a.
Rubinetteria

MADE IN ITALY
www.bianchifratelli.it

 Raccordo OR
 Adaptor with O-Ring
 Racores con O-Ring

300 connection 24x19

Code	Version	Size (D)	Smooth	€	D1	H	I	L	M	Pack
3000050400		3/4x1/2	●	1,16	-	-	-	-	-	1

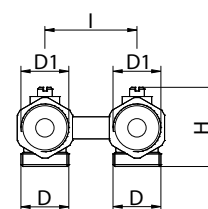

 Valvola "H" doppia
 ad angolo
 Angle "H" double
 valve
 Válvula "H" doble
 a esquadra

301

Code	Version	Size (D)	Smooth	€	D1	H	h	I	L	Pack
3010000500		3/4	●	13,70	3/4	42	-	50	-	1

301X connection 24x19

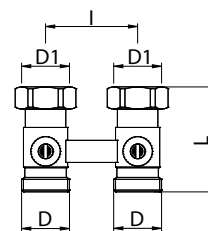
Code	Version	Size (D)	Smooth	€	D1	H	h	I	L	Pack
301X000500		24x19	●	13,70	3/4	42	-	50	-	1



 Valvola "H" doppia
 diritta
 Straight "H" double
 valve
 Válvula "H" doble
 recta

303

Code	Version	Size (D)	Smooth	€	D1	H	h	I	L	Pack
3030000500		3/4	●	12,62	3/4	-	-	50	48	1

303X connection 24x19

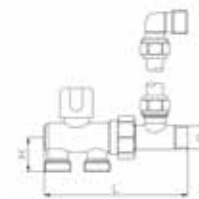
Code	Version	Size (D)	Smooth	€	D1	H	h	I	L	Pack
303X000500		24x19	●	12,62	3/4	-	-	50	48	1



Valvola monotubo per piastra attacco **24x19**

Valve for monotube system for plate **24x19** tube connection

Válvula monotubo para placa empalme **24x19**

383 connection 24x19

Code	Version	Size (D)	Smooth	€	D1	H	h	l	L	Pack
3830000400		1/2"	●	24,70	24x19	30	-	-	132	5



Valvola monotubo termostaticabile c/detentore By-pass incorporato

384

Code	Version	Size (D)	Smooth	€	D1	H	h	l	L	Pack
3840000400		1/2	●	17,94	-	48,5	-	-	140	5

Thermostatic monotube valve with incorporated lockshield By-Pass

Válvula monotubo termostatica con detentor By-pass incorporado

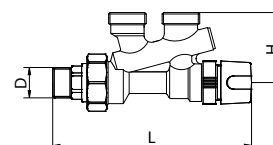

Valvola monotubo 4 vie attacco Eurocono

385

Code	Version	Size (D)	Smooth	€	D1	H	h	l	L	Pack
3850000400		1/2	●	15,96	-	38	-	-	106	5
3850000500		3/4	●	16,24	-	38	-	-	106	5

4 ways eurokonus valve for monotube systems

Válvula monotubo Eurocono 4 vías

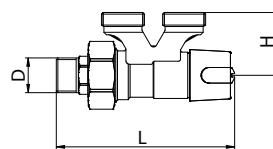

385X connection 24x19

Code	Version	Size (D)	Smooth	€	D1	H	h	l	L	Pack
385X000400		1/2	●	15,96	24x19	38	-	-	106	5



BIANCHI F.lli S.p.a.
Rubinetteria

Per collegamento al tubo di rame: Art. 212E
Per collegamento al tubo multistrato: Art. 219E
Per collegamento al tubo di plastica: Art. 220E

Finitura: ● Giallo/Yellow
Smooth: ● Cromo/Chrome
● Nichel/Nickel



Valvola monotubo
termostatica 4 vie
con volantino micro-
metrico

385T

Code	Version	Size (D)	Smooth	€	D1	H	h	l	L	Pack
385T0004V0		1/2	●	18,95	-	38	-	-	121	5
385T0005V0		3/4	●	19,25	-	38	-	-	121	5

4 ways thermostatic valve for monotube systems with micrometric wheelhandle
Valvula monotubo termostatica 4 vias con volante micrometrico

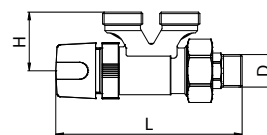

Valvola radiatore
a corpo reverso
termostattizzabile
con cappuccio di
protezione. Attacco
Eurocono per tubo
rame, plastica e
multistrato

3851

Code	Version	Size (D)	Smooth	€	D1	H	h	l	L	Pack
3851000400		1/2	●	10,00	-	42	-	51	96	10

Inversed angle radiator thermostatic valve with protection cap. Euroconus connections for copper, plastic and multilayer pipe

Valvula radiador con cuerpo reverso termostático con capuchón de protección para tubo de cobre, tubo plástico y multicapa

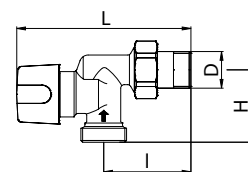

Valvola radiatore diritta
termostattizzabile
con volantino e raccordo a
90°. Attacco Eurocono
per tubo rame,
plastica e multistrato

3851D

Code	Version	Size (D)	Smooth	€	D1	H	h	l	L	Pack
3851D00400		1/2	●	14,08	3/4	115	63	-	93	10

Straight thermostatic valve with protection cap and 90° fitting. Euroconus connections for copper, plastic and multilayer pipe

Valvula recta termostática con capuchón de protección. Empalmes Eurocono para tubo de cobre, tubo plástico y multicapa

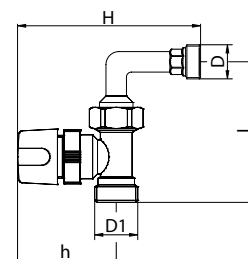

Raccordo 90°
90° fitting
Union 90°

3852

Code	Version	Size (D)	Smooth	€	D1	H	h	l	L	Pack
3852000400		1/2	●	6,83	3/4	40	-	-	52	25

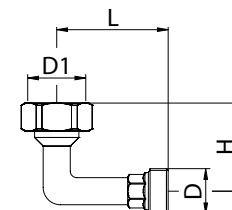



Distributore a 4 vie con attacchi a pavimento. Portata massima al corpo scaldante: 50% della portata dell'anello. Attacchi Eurocono per tubo rame e tubo plastica

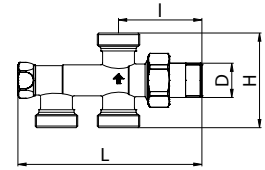

3853

Code	Version	Size (D)	Smooth	€	D1	H	h	l	L	Pack
3853000400		1/2	●	11,26	-	58	-	52	112	10

Per impianti monotubo e bitubo - *For monotube and bitube system*
Para instalaciones monotubo y bitubo

4-ways distributor with floor connections. Maximun flow to radiator: 50% of delivery capacity heating system. Euroconus connections for copper, plastic and multilayer pipe

Distribuidor de 4 vías con empalmes al suelo. Capacidad máxima de suministro al cuerpo calentador: 50% de la capacidad del anillo. Empalmes Eurocono para tubo cobre, tubo plástico y multicapa



Distributore a 4 vie con attacchi a pavimento. Portata massima al corpo scaldante: 100% della portata dell'anello. Attacchi Eurocono per tubo rame, plastica e multistrato

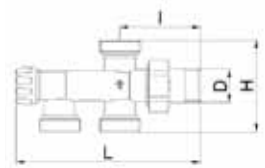

3854

Code	Version	Size (D)	Smooth	€	D1	H	h	l	L	Pack
3854000400		1/2	●	11,26	-	58	-	52	112	10

Per impianti bitubo - *For bitube system - Para instalaciones bitubo*

4-ways distributor with floor connections. Maximun flow to radiator: 100% of delivery capacity heating system. Euroconus connections for copper, plastic and multilayer pipe

Distribuidor de 4 vías con empalmes al suelo. Capacidad máxima de suministro al cuerpo calentador: 100% de la capacidad del anillo. Empalmes Eurocono para tubo cobre, tubo plástico y multicapa



Distributore a 4 vie con attacchi a parete. Portata massima al corpo scaldante: 50% della portata dell'anello. Attacchi Eurocono per tubo rame, plastica e multistrato

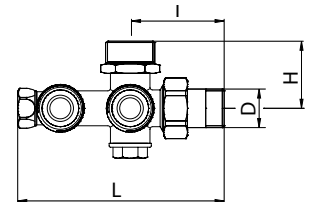

3855

Code	Version	Size (D)	Smooth	€	D1	H	h	l	L	Pack
3855000400		1/2	●	13,29	-	35	-	52	112	10

Per impianti monotubo e bitubo - *For monotube and bitube system*
Para instalaciones monotubo y bitubo

4-ways distributor with wall connections. Maximun flow to radiator: 50% of delivery capacity heating system. Euroconus connections for copper, plastic and multilayer pipe

Distribuidor de 4 vías con conexion a pared, capacidad 50%. Empalmes Eurocono para tubo cobre, tubo plástico y multicapa



Distributore a 4 vie con attacchi a parete. Portata massima al corpo scaldante: 100% della portata dell'anello. Attacchi Eurocono per tubo rame, plastica e multistrato

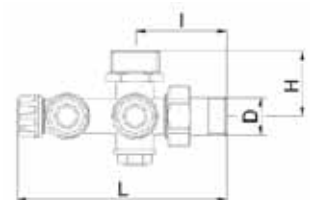

3856

Code	Version	Size (D)	Smooth	€	D1	H	h	l	L	Pack
3856000400		1/2	●	13,29	-	35	-	52	112	10

Per impianti bitubo - *For bitube system - Para instalaciones bitubo*

4-ways distributor with wall connections. Maximun flow to radiator: 100% of delivery capacity heating system. Euroconus connections for copper, plastic and multilayer pipe

Distribuidor de 4 vías con conexion a pared, capacidad 100%. Empalmes Eurocono para tubo cobre, tubo plástico y multicapa



Tubo cromato per collegamento valvola monotubo e bitubo

Chrome plated pipe to connect inverse and straight radiator valves

Tubo cromado para unión válvula monoutbo y bitubo

3859

Code	Version	Size (D)	Smooth	€	D1	H	h	l	L	Pack
3859C06000	Ø15	600	●	6,16	-	-	-	-	600	5
3859C11150	Ø15	1100	●	9,60	-	-	-	-	1100	5



Volantino micrometrico per valvola termostatica

Micrometric wheelhandle for thermostatic valve

Volante micrometrico para válvula termostática

399

Code	Version	Size (D)	Smooth	€	D1	H	h	l	L	Pack
3990000000	-	-	-	1,73	-	-	-	-	-	10



Fascetta antimanomissione

Anti-opening band

Abrazadera anti manipulation

399B

Code	Version	Size (D)	Smooth	€	D1	H	h	l	L	Pack
399B000000	-	-	-	0,60	-	-	-	-	-	10



Testa termoelettrica a 2 cavi

Thermoelectric head 2 cables

Cabeza termoelectrica 2 cables

350

Code	Version	Size (D)	Smooth	€	D1	H	h	l	L	Pack
3500000000	230 V	M30X1,5	-	35,39	-	56	-	-	-	1
35000V2400	24 V	M30X1,5	-	35,39	-	56	-	-	-	1

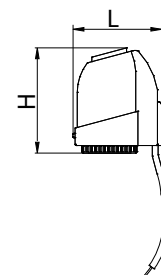

Testa termoelettrica con micro-switch a 4 cavi (normalmente in posizione chiusa)

351

Code	Version	Size (D)	Smooth	€	D1	H	h	l	L	Pack
3510000000	230 V	M30X1,5	-	38,60	-	56	-	-	-	1
35100V2400	24 V	M30X1,5	-	38,60	-	56	-	-	-	1

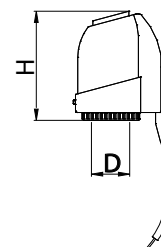

Thermoelectric head with micro-switch and 4 power cables (normally in closed position)
Cabeza termoelectrica con micro-switch, 4 cables (normalmente serada)



Testa termostatica con sensore a liquido
Thermostatic head with liquid sensor
Cabezal termostático con captador de líquido

400

Code	Version	Size (D)	Smooth	€	D1	H	h	l	L	Pack
4000000000		-	-	14,09	50	80	-	-	-	10

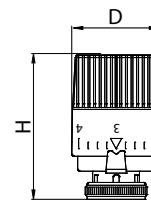

Testa termostatica con sensore a liquido
Thermostatic head with liquid sensor
Cabezal termostático con captador de líquido

400A

Code	Version	Size (D)	Smooth	€	D1	H	h	l	L	Pack
400A000000		-	-	14,45	49	75	-	-	-	1

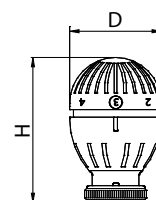

Testa termostatica con sensore a cera
Thermostatic head with wax sensor
Cabezal termostático con captador sensor cera

400B

Code	Version	Size (D)	Smooth	€	D1	H	h	l	L	Pack
400B000000		-	-	12,62	43	74	-	-	-	1

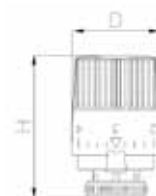

Testa termostatica con comando incorporato e sensore a distanza
Thermostatic head with integrated control and remote sensor
Cabezal termostático con sensor remoto

400C

Code	Version	Size (D)	Smooth	€	D1	H	h	l	L	Pack
400C000000		46	-	36,50	36	85	100	-	-	1

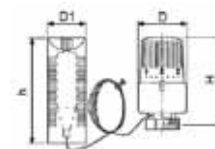



Testa termostatica cromata a liquido, corpo bianco

Chromed Thermostatic head, with liquid sensor, white body

Cabezal termostático cromada con captador de liquido, cuerpo blanco

400L

Code	Version	Size (D)	Smooth	€	D1	H	h	l	L	Pack
400L000000		-	-	29,85	40	82	-	-	-	1

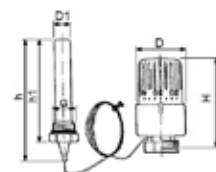

Testa termostatica con sonda a distanza e portasonda

Thermostatic head, with probe and probe holder

Cabezal termostático con sonda y soporte de la sonda

400P

Code	Version	Size (D)	Smooth	€	D1	H	h	l	L	Pack
400P000000		46	-	48,16	15	85	110	95	-	1

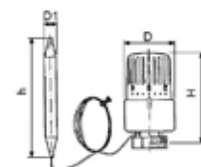

NEW DESIGN



Testa termostatica con sonda a distanza

Thermostatic head, with probe

Cabezal termostático con sonda

400 S

Code	Version	Size (D)	Smooth	€	D1	H	h	l	L	Pack
400S000000		46	-	40,80	11	85	110	-	-	1

NEW DESIGN



Valvola ad angolo termostaticizzabile attacco tubo ferro

401T

Code	Version	Size (D)	Smooth	€	D1	H	h	l	L	Pack
401TN00300		3/8	●	8,19	-	63	20,5	-	51	10
401TN0030G	O-Ring	3/8	●	8,70	-	63	20,5	-	51	10
401TN00400		1/2	●	8,57	-	65	22,5	-	53	10
401TN0040G	O-Ring	1/2	●	9,16	-	65	22,5	-	53	10
401TN00500		3/4	●	11,64	-	70	25,5	-	58	5
401TN0050G	O-Ring	3/4	●	12,47	-	70	25,5	-	58	5

Angle thermostatic radiator valve for iron pipe

Válvula acodada termostática empalme tubo de hierro

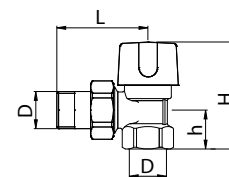

Valvola diritta termostaticizzabile attacco tubo ferro

403T

Code	Version	Size (D)	Smooth	€	D1	H	h	l	L	Pack
403TN00300		3/8	●	8,42	-	49	-	-	72	10
403TN0030G	O-Ring	3/8	●	9,09	-	49	-	-	72	10
403TN00400		1/2	●	9,33	-	49	-	-	83	10
403TN0040G	O-Ring	1/2	●	10,16	-	49	-	-	83	10
403TN00500		3/4	●	13,01	-	49	-	-	93	5
403TN0050G	O-Ring	3/4	●	14,00	-	49	-	-	93	5

Straight thermostatic radiator valve for iron pipe

Válvula recta termostática empalme tubo de hierro

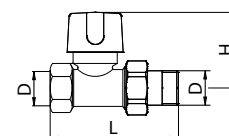

Valvola ad angolo termostaticizzabile attacco tubo rame, multistrato e Pex

409T

Code	Version	Size (D)	Smooth	€	D1	H	h	l	L	Pack
409TN00300		3/8	●	8,19	-	64	21,5	-	51	10
409TN0030G	O-Ring	3/8	●	8,87	-	64	21,5	-	51	10
409TN00400		1/2	●	8,40	-	64	21,5	-	54	10
409TN0040G	O-Ring	1/2	●	8,98	-	64	21,5	-	54	10

Angle thermostatic radiator valve for copper, multilayer and Pex tube

Válvula acodada termostática empalme tubo de cobre, multicapa y Pex

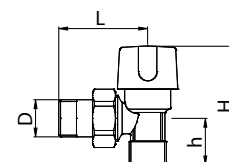



Valvola ad angolo termostattizzabile Eurocono attacco tubo rame, multistrato e Pex

409TE

Code	Version	Size (D)	Smooth	€	D1	H	h	l	L	Pack
409TE00400		1/2	●	8,63	3/4	69	26	-	54	10
409TE0040G	O-Ring	1/2	●	9,44	3/4	69	26	-	54	10

Angle Euroconus thermostatic radiator valve for copper, multilayer and Pex tube
 Válvula acodada termostática Eurocono empalme tubo de cobre, multicapa y Pex

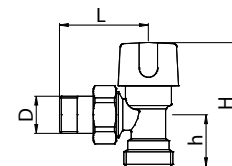
409TX connection 24x19

Code	Version	Size (D)	Smooth	€	D1	H	h	l	L	Pack
409TX00400		1/2	●	8,62	24x19	69	26	-	54	10
409TX0040G	O-Ring	1/2	●	9,63	24x19	69	26	-	54	10



Valvola diritta termostattizzabile con cappuccio di protezione, attacco tubo rame, multistrato e Pex

411T

Code	Version	Size (D)	Smooth	€	D1	H	h	l	L	Pack
411TN00300		3/8	●	8,42	-	49	-	-	71	10
411TN0030G	O-Ring	3/8	●	9,00	-	49	-	-	71	10
411TN00400		1/2	●	8,70	-	49	-	-	74	10
411TN0040G	O-Ring	1/2	●	9,44	-	49	-	-	74	10

Straight thermostatic radiator valve with protection cap for copper, multilayer and Pex
 Válvula recta termostática con capuchón de protección, empalme tubo de cobre, multicapa y Pex

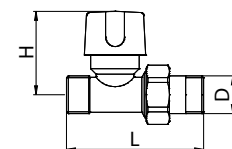

Valvola diritta termostattizzabile Eurocono con cappuccio di protezione, attacco tubo rame, multistrato e Pex

411TE

Code	Version	Size (D)	Smooth	€	D1	H	h	l	L	Pack
411TE00400		1/2	●	9,43	-	49	-	-	74	10
411TE0040G	O-Ring	1/2	●	10,17	-	49	-	-	74	10

Straight Euroconus thermostatic radiator valve with protection cap for copper, multilayer and Pex
 Válvula recta termostática Eurocono con capuchón de protección, empalme tubo de cobre, multicapa y Pex

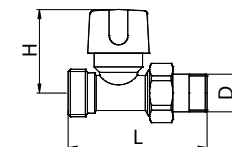
411TX connection 24x19

Code	Version	Size (D)	Smooth	€	D1	H	h	l	L	Pack
411TX00400		1/2	-	9,63	24x19	49	-	-	74	10
411TX0040G	O-Ring	1/2	-	10,38	24x19	49	-	-	74	10



Valvola ad angolo termostattizzabile con volantino, attacco tubo ferro

Angle thermostatic radiator valve with wheelhandle for iron pipe

Válvula acodada termostática con volante micrometrico, empalme tubo de hierro

401TV

Code	Version	Size (D)	Smooth	€	D1	H	h	l	L	Pack
401TN003V0		3/8	●	8,94	-	77	20,5	-	51	10
401TN003VG	O-Ring	3/8	●	9,61	-	77	20,5	-	51	10
401TN004V0		1/2	●	9,14	-	79	22,5	-	53	10
401TN004VG	O-Ring	1/2	●	9,90	-	79	22,5	-	53	10
401TN005V0		3/4	●	12,62	-	84	25,5	-	58	5
401TN005VG	O-Ring	3/4	●	13,53	-	84	25,5	-	58	5

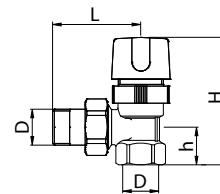

Valvola diritta termostattizzabile c/volantino, attacco tubo ferro

Straight thermostatic radiator valve with wheelhandle for iron pipe

Válvula recta termostática con volante micrometrico, empalme tubo de hierro

403TV

Code	Version	Size (D)	Smooth	€	D1	H	h	l	L	Pack
403TN003V0		3/8	●	9,13	-	63	-	-	72	10
403TN003VG	O-Ring	3/8	●	9,78	-	63	-	-	72	10
403TN004V0		1/2	●	10,02	-	63	-	-	83	10
403TN004VG	O-Ring	1/2	●	10,80	-	63	-	-	83	10
403TN005V0		3/4	●	13,80	-	63	-	-	93	5
403TN005VG	O-Ring	3/4	●	14,77	-	63	-	-	93	5

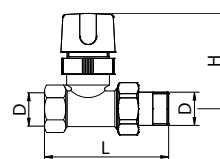

Valvola ad angolo termostattizzabile con volantino micrometrico, attacco tubo rame, multistrato e Pex

409TV

Code	Version	Size (D)	Smooth	€	D1	H	h	l	L	Pack
409TN003V0		3/8	●	8,96	-	78	21,5	-	51	10
409TN003VG	O-Ring	3/8	●	9,62	-	78	21,5	-	51	10
409TN004V0		1/2	●	9,16	-	78	21,5	-	54	10
409TN004VG	O-Ring	1/2	●	9,94	-	78	21,5	-	54	10

Angle thermostatic radiator valve with micrometric wheelhandle for copper, multilayer and Pex tube

Válvula acodada termostática con volante micrometrico, empalme tubo de cobre, multicapa y Pex

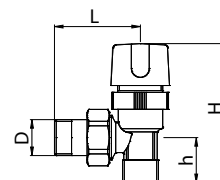

Valvola ad angolo termostattizzabile Eurocono con volantino micrometrico, attacco tubo rame, multistrato e Pex

409TVE

Code	Version	Size (D)	Smooth	€	D1	H	h	l	L	Pack
409TE004V0		1/2	●	9,54	3/4	85	26	-	54	10
409TE004VG	O-Ring	1/2	●	10,34	3/4	85	26	-	54	10

Angle Euroconus thermostatic radiator valve with micrometric wheelhandle for copper, multilayer and Pex tube

Válvula acodada termostática Eurocono con volante micrometrico, empalme tubo de cobre, multicapa y Pex

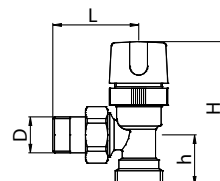



BIANCHI F.lli S.p.a.
Rubineria

Finitura: ● Giallo/Yellow
Smooth: ● Cromo/Chrome
● Nichel/Nickel



Valvola diritta termostaticizzabile con volantino micro-metrico, attacco tubo rame, multistrato e Pex

411TV

Code	Version	Size (D)	Smooth	€	D1	H	h	l	L	Pack
411TN003V0		3/8	●	9,22	-	63	-	-	71	10
411TN003VG	O-Ring	3/8	●	9,92	-	63	-	-	71	10
411TN004V0		1/2	●	9,68	-	63	-	-	74	10
411TN004VG	O-Ring	1/2	●	10,41	-	63	-	-	74	10

Straight thermostatic radiator valve with micrometric wheelhandle for copper, multilayer and Pex tube
Válvula recta termostática con volante micrometrico, empalme tubo de cobre, multicapa y Pex

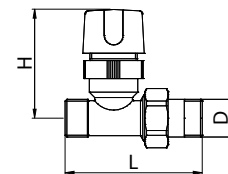

Valvola diritta termostaticizzabile Eurocono con volantino micro-metrico, attacco tubo rame, multistrato e Pex

411TVE

Code	Version	Size (D)	Smooth	€	D1	H	h	l	L	Pack
411TE004V0		1/2	●	10,36	3/4	63	-	-	74	10
411TE004VG	O-Ring	1/2	●	11,12	3/4	63	-	-	74	10

Straight Euroconus thermostatic radiator valve with micrometric wheelhandle for copper, multilayer and Pex
Válvula recta termostática Eurocono con volante micrometrico, empalme tubo de cobre, multicapa y Pex

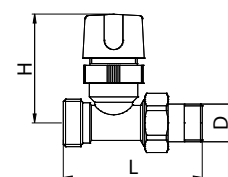

Valvola ad angolo semplice regolaggio
Angle radiator valve
Válvula acodada ajuste simple

401

Code	Version	Size (D)	Smooth	€	D1	H	h	l	L	Pack
4010N00300		3/8	●	6,98	-	70	20	-	49	10
4010N0030G	O-Ring	3/8	●	7,71	-	70	20	-	49	10
4010N00400		1/2	●	7,64	-	72	22	-	50	10
4010N0040G	O-Ring	1/2	●	8,28	-	72	22	-	50	10
4010N00500		3/4	●	9,75	-	75	22,5	-	58	8
4010N0050G	O-Ring	3/4	●	10,80	-	75	22,5	-	58	8

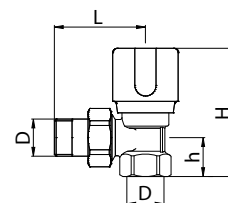

Detentore ad angolo a regolazione con cappuccio ABS
Angle lockshield-valve with plastic cap
Detentor acodado con dispositivo de regulación con capuchón ABS

402

Code	Version	Size (D)	Smooth	€	D1	H	h	l	L	Pack
4020N00300		3/8	●	5,92	-	52	20	-	49	10
4020N0030G	O-Ring	3/8	●	6,57	-	52	20	-	49	10
4020N00400		1/2	●	6,51	-	55	22	-	50	10
4020N0040G	O-Ring	1/2	●	7,09	-	55	22	-	50	10
4020N00500		3/4	●	9,11	-	58	22,5	-	58	8
4020N0050G	O-Ring	3/4	●	9,96	-	58	22,5	-	58	8

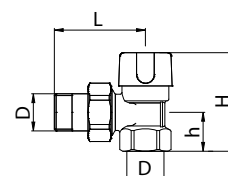

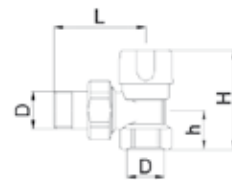

Detentore ad angolo a regolazione con cappuccio in ottone

Angle lockshield-valve with brass cap

Detentor acodado con dispositivo de regulación con capuchón de latón

402B

Code	Version	Size (D)	Smooth	€	D1	H	h	l	L	Pack
402BN00300		3/8	●	6,80	-	52	20	-	49	10
402BN0030G	O-Ring	3/8	●	7,58	-	52	20	-	49	10
402BN00400		1/2	●	7,31	-	55	22	-	50	10
402BN0040G	O-Ring	1/2	●	7,82	-	55	22	-	50	10
402BN00500		3/4	●	10,06	-	58	22,5	-	58	8
402BN0050G	O-Ring	3/4	●	10,82	-	58	22,5	-	58	8

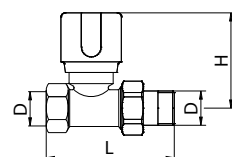

Valvola diritta semplice regolaggio

Straight radiator valve

Válvula recta ajuste simple

403

Code	Version	Size (D)	Smooth	€	D1	H	h	l	L	Pack
403N00300		3/8	●	7,51	-	57	-	-	71	10
403N0030G	O-Ring	3/8	●	8,28	-	57	-	-	71	10
403N00400		1/2	●	8,40	-	59	-	-	78	10
403N0040G	O-Ring	1/2	●	8,84	-	59	-	-	78	10
403N00500		3/4	●	10,76	-	60	-	-	93	6
403N0050G	O-Ring	3/4	●	11,81	-	60	-	-	93	6

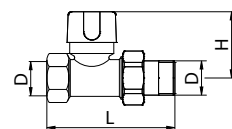

Detentore diritto a regolazione con cappuccio ABS

Straight lockshield-valve with plastic cap

Detentor recto con dispositivo de regulación con capuchón ABS

404

Code	Version	Size (D)	Smooth	€	D1	H	h	l	L	Pack
404N00300		3/8	●	6,43	-	39	-	-	71	10
404N0030G	O-Ring	3/8	●	7,05	-	39	-	-	71	10
404N00400		1/2	●	7,08	-	41	-	-	78	10
404N0040G	O-Ring	1/2	●	7,84	-	41	-	-	78	10
404N00500		3/4	●	10,03	-	44	-	-	93	6
404N0050G	O-Ring	3/4	●	11,05	-	44	-	-	93	6



Detentore diritto a regolazione con cappuccio in ottone

Straight lockshield-valve with brass cap

Detentor recto con dispositivo de regulación con capuchón de latón

404B

Code	Version	Size (D)	Smooth	€	D1	H	h	l	L	Pack
404BN00300		3/8	●	7,28	-	39	-	-	71	10
404BN0030G	O-Ring	3/8	●	7,92	-	39	-	-	71	10
404BN00400		1/2	●	7,99	-	41	-	-	78	10
404BN0040G	O-Ring	1/2	●	8,46	-	41	-	-	78	10
404BN00500		3/4	●	10,77	-	44	-	-	93	6
404BN0050G	O-Ring	3/4	●	11,77	-	44	-	-	93	6

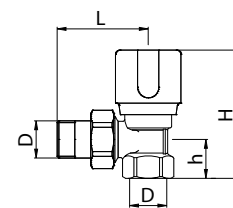

Valvola ad angolo
doppio regolaggio
*Double regulating
angle radiator valve*
*Válvula acodada
doble ajuste*

405

Code	Version	Size (D)	Smooth	€	D1	H	h	l	L	Pack
4050N00300		3/8	●	8,68	-	70	20	-	49	10
4050N0030G	O-Ring	3/8	●	9,43	-	70	20	-	49	10
4050N00400		1/2	●	9,35	-	72	22	-	50	10
4050N0040G	O-Ring	1/2	●	9,96	-	72	22	-	50	10

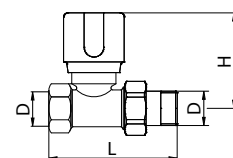

Valvola diritta doppio
regolaggio
*Double regulating
straight radiator valve*
*Válvula recta doble
ajuste*

406

Code	Version	Size (D)	Smooth	€	D1	H	h	l	L	Pack
4060N00300		3/8	●	9,18	-	57	-	-	71	10
4060N0030G	O-Ring	3/8	●	9,91	-	57	-	-	71	10
4060N00400		1/2	●	10,12	-	59	-	-	78	10
4060N0040G	O-Ring	1/2	●	10,91	-	59	-	-	78	10

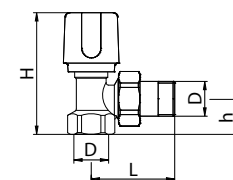

Valvola ad angolo
tipo export
*Angle radiator valve,
light pattern*
*Válvula acodada tipo
export*

407

Code	Version	Size (D)	Smooth	€	D1	H	h	l	L	Pack
4070N00300		3/8	●	5,17	-	72	19	-	48	10
4070N0030G	O-Ring	3/8	●	5,84	-	72	19	-	48	10
4070N00400		1/2	●	5,52	-	74	21,5	-	50	10
4070N0040G	O-Ring	1/2	●	6,27	-	74	21,5	-	50	10

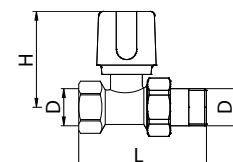

Valvola diritta
tipo export
*Straight radiator
valve, light pattern*
*Válvula recta
tipo export*

407D

Code	Version	Size (D)	Smooth	€	D1	H	h	l	L	Pack
407DN00300		3/8	●	5,69	-	59	-	-	70	10
407DN0030G	O-Ring	3/8	●	6,37	-	59	-	-	70	10
407DN00400		1/2	●	5,95	-	60	-	-	72	10
407DN0040G	O-Ring	1/2	●	6,68	-	60	-	-	72	10



Detentore ad angolo
tipo export
*Angle lockshield-
valve, light pattern*
*Detentor acodado
tipo export*

408

Code	Version	Size (D)	Smooth	€	D1	H	h	l	L	Pack
4080N00300		3/8	●	4,28	-	43	19	-	48	10
4080N0030G	O-Ring	3/8	●	4,95	-	43	19	-	48	10
4080N00400		1/2	●	4,66	-	45	21	-	50	10
4080N0040G	O-Ring	1/2	●	5,39	-	45	21	-	50	10

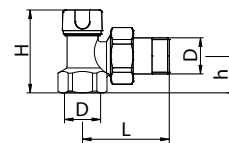

Detentore ad angolo
tipo export, cappuccio
ottone
*Angle lockshield-
valve, light pattern,
brass cap*
*Detentor acodado
tipo export,
capuchón de latón*

408B

Code	Version	Size (D)	Smooth	€	D1	H	h	l	L	Pack
4080N003B0		3/8	●	4,46	-	43	19	-	48	10
4080N003BG	O-Ring	3/8	●	5,11	-	43	19	-	48	10
4080N004B0		1/2	●	4,83	-	45	21	-	50	10
4080N004BG	O-Ring	1/2	●	5,55	-	45	21	-	50	10

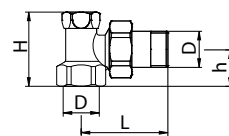

Detentore dritto
tipo export
*Straight lockshield-
valve, light pattern*
*Detentor recto
tipo export*

408D

Code	Version	Size (D)	Smooth	€	D1	H	h	l	L	Pack
408DN00300		3/8	●	4,74	-	31	-	-	70	10
408DN0030G	O-Ring	3/8	●	5,40	-	31	-	-	70	10
408DN00400		1/2	●	5,14	-	31	-	-	72	10
408DN0040G	O-Ring	1/2	●	5,86	-	31	-	-	72	10

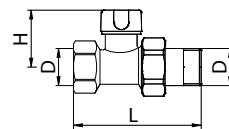

Detentore dritto tipo
export, cappuccio
ottone
*Straight lockshield-
valve, light pattern,
brass cap*
*Detentor recto
tipo export,
capuchón de latón*

408DB

Code	Version	Size (D)	Smooth	€	D1	H	h	l	L	Pack
408DN003B0		3/8	●	4,90	-	31	-	-	70	10
408DN003BG	O-Ring	3/8	●	5,56	-	31	-	-	70	10
408DN004B0		1/2	●	5,30	-	31	-	-	72	10
408DN004BG	O-Ring	1/2	●	6,02	-	31	-	-	72	10

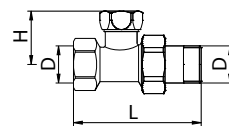



BIANCHI F.lli S.p.a.
Rubinetteria

Finitura: ● Giallo/Yellow
Smooth: ● Cromo/Chrome
● Nichel/Nickel



Valvola ad angolo
attacco tubo rame,
multistrato e Pex

Angle radiator valve for
copper, multilayer and
Pex tube

Válvula acodada
empalme tubo de
cobre, multicapa y Pex

409

Code	Version	Size (D)	Smooth	€	D1	H	h	l	L	Pack
409N00300		3/8	●	6,76	-	71,5	21,5	-	50	10
409N0030G	O-Ring	3/8	●	7,48	-	71,5	21,5	-	50	10
409N00400		1/2	●	7,22	-	71,5	21,5	-	51	10
409N0040G	O-Ring	1/2	●	7,78	-	71,5	21,5	-	51	10

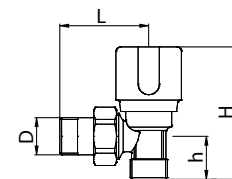

Valvola angolo
doppio regolaggio per
tubo rame, multistrato
e Pex

Double regulating
angle radiator valve for
copper, multilayer and
Pex tube

Válvula acodada doble
ajuste para tubo de
cobre, multicapa y Pex

409DR

Code	Version	Size (D)	Smooth	€	D1	H	h	l	L	Pack
409RN00400		1/2	●	8,44	-	71,5	21,5	-	51	10
409RN0040G	O-Ring	1/2	●	9,22	-	71,5	21,5	-	51	10

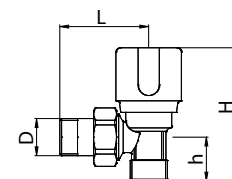

IN ESAURIMENTO



Detentore ad angolo
a regolazione,
attacco tubo rame,
multistrato e Pex,
con cappuccio ABS

410

Code	Version	Size (D)	Smooth	€	D1	H	h	l	L	Pack
410N00300		3/8	●	5,61	-	53,5	21,5	-	50	10
410N0030G	O-Ring	3/8	●	6,31	-	53,5	21,5	-	50	10
410N00400		1/2	●	5,99	-	53,5	21,5	-	51	10
410N0040G	O-Ring	1/2	●	6,63	-	53,5	21,5	-	51	10

Angle lockshield-valve for copper, multilayer and Pex tube, with plastic cap

Detentor acodado con dispositivo de regulación, empalme tubo de cobre, multicapa y Pex, con capuchón ABS

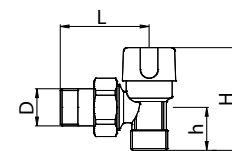

Detentore ad angolo
a regolazione,
attacco tubo rame,
multistrato e Pex,
con cappuccio in
ottone

410B

Code	Version	Size (D)	Smooth	€	D1	H	h	l	L	Pack
410BN00300		3/8	●	6,50	-	53,5	21,5	-	50	10
410BN0030G	O-Ring	3/8	●	7,22	-	53,5	21,5	-	50	10
410BN00400		1/2	●	6,85	-	53,5	21,5	-	51	10
410BN0040G	O-Ring	1/2	●	7,34	-	53,5	21,5	-	51	10

Angle lockshield-valve for copper, multilayer and Pex tube, with brass cap

Detentor acodado con dispositivo de regulación, empalme tubo de cobre, multicapa y Pex, con capuchón de latón

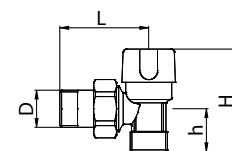



Valvola diritta
attacco tubo rame,
multistrato e Pex
*Straight radiator valve
with wheelhandle, for
copper, multilayer and
Pex tube*
*Válvula recta
empalme tubo de co-
bre, multicapa y Pex*

411

Code	Version	Size (D)	Smooth	€	D1	H	h	l	L	Pack
411N00300		3/8	●	7,58	-	57	-	-	71	10
411N0030G	O-Ring	3/8	●	8,29	-	57	-	-	71	10
411N00400		1/2	●	7,94	-	57	-	-	73	10
411N0040G	O-Ring	1/2	●	8,49	-	57	-	-	73	10

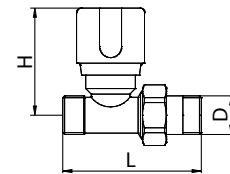

Detentore diritto
a regolazione, con
cappuccio ABS
attacco tubo rame,
multistrato e Pex

412

Code	Version	Size (D)	Smooth	€	D1	H	h	l	L	Pack
412N00300		3/8	●	6,46	-	40	-	-	71	10
412N0030G	O-Ring	3/8	●	7,18	-	40	-	-	71	10
412N00400		1/2	●	6,64	-	40	-	-	73	10
412N0040G	O-Ring	1/2	●	7,31	-	40	-	-	73	10

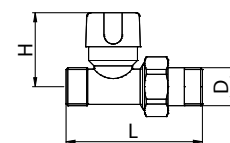

Straight regulation lockshield-valve with plastic cap, for copper, multilayer and Pex tube
Detentor recto con dispositivo de regulación y capuchón ABS, empalme tubo de cobre, multicapa y Pex



Detentore diritto
a regolazione con
cappuccio in ottone,
attacco tubo rame,
multistrato e Pex

412B

Code	Version	Size (D)	Smooth	€	D1	H	h	l	L	Pack
412BN00300		3/8	●	7,19	-	40	-	-	71	10
412BN0030G	O-Ring	3/8	●	7,94	-	40	-	-	71	10
412BN00400		1/2	●	7,52	-	40	-	-	73	10
412BN0040G	O-Ring	1/2	●	8,17	-	40	-	-	73	10

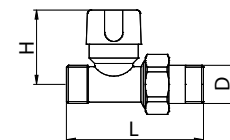

Straight regulation lockshield-valve with brass cap, for copper, multilayer and Pex tube
Detentor recto con dispositivo de regulación y capuchón en latón, empalme tubo de cobre, multicapa y Pex



Valvola ad angolo tipo
export, attacco tubo
rame, multistrato e Pex
*Angle radiator valve
light pattern for cop-
per, multilayer and
Pex tube*
*Válvula acudada tipo
export, empalme tubo
de cobre, multicapa
y Pex*

413

Code	Version	Size (D)	Smooth	€	D1	H	h	l	L	Pack
413N00300		3/8	●	4,88	-	75,5	21,5	-	46	10
413N0030G	O-Ring	3/8	●	5,57	-	75,5	21,5	-	46	10
413N00400		1/2	●	5,26	-	75,5	21,5	-	48	10
413N0040G	O-Ring	1/2	●	6,02	-	75,5	21,5	-	48	10

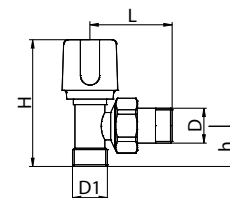



BIANCHI F.lli S.p.a.
Rubinetteria

Finitura: ● Giallo/Yellow
Smooth: ● Cromo/Chrome
● Nichel/Nickel



Detentore ad angolo tipo export, attacco tubo rame, multistrato e Pex

Angle lockshield-valve light pattern for copper, multilayer and Pex tube

Detentor acodado tipo export, empalme tubo de cobre, multicapa y Pex

414

Code	Version	Size (D)	Smooth	€	D1	H	h	l	L	Pack
4140N00300		3/8	●	4,15	-	44,5	21,5	-	46	10
4140N0030G	O-Ring	3/8	●	4,71	-	44,5	21,5	-	46	10
4140N00400		1/2	●	4,40	-	44,5	21,5	-	48	10
4140N0040G	O-Ring	1/2	●	5,13	-	44,5	21,5	-	48	10

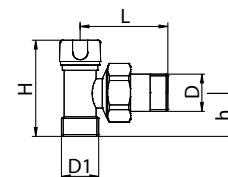

Detentore ad angolo tipo export con cappuccio ottone, attacco tubo rame, multistrato e Pex

Angle lockshield-valve light pattern brass cap for copper, multilayer and Pex tube

Detentor acodado tipo export capuchón latón, empalme tubo de cobre, multicapa y Pex

414B

Code	Version	Size (D)	Smooth	€	D1	H	h	l	L	Pack
4140N003B0		3/8	●	4,34	-	44,5	21,5	-	46	10
4140N003BG	O-Ring	3/8	●	5,00	-	44,5	21,5	-	46	10
4140N004B0		1/2	●	4,57	-	44,5	21,5	-	48	10
4140N004BG	O-Ring	1/2	●	5,30	-	44,5	21,5	-	48	10

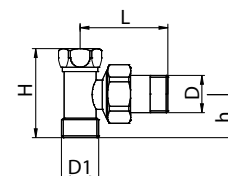

Valvola ad angolo Eurocono tipo export, attacco tubo rame, multistrato e Pex

413E

Code	Version	Size (D)	Smooth	€	D1	H	h	l	L	Pack
413E000400		1/2	●	5,51	3/4	80	26	-	47	10
413E00040G	O-Ring	1/2	●	6,29	3/4	80	26	-	47	10

Euroconus angle radiator valve light pattern for copper, multilayer and Pex tube

Válvula acodada Eurocono tipo export, empalme tubo de cobre, multicapa y Pex

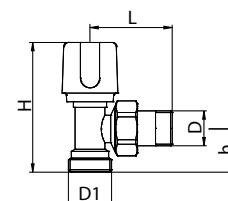

413X

connection 24x19

Code	Version	Size (D)	Smooth	€	D1	H	h	l	L	Pack
413X000400		1/2	●	5,51	24x19	80	26	-	47	10



Detentore angolo Eurocono tipo export, attacco tubo rame, multistrato e Pex

414E

Code	Version	Size (D)	Smooth	€	D1	H	h	l	L	Pack
414E000400		1/2	●	4,71	3/4	49	26	-	47	10
414E00040G	O-Ring	1/2	●	5,44	3/4	49	26	-	47	10

*Euroconus angle lockshield-valve light pattern for copper, multilayer and Pex tube
Detentor acodado Eurocono tipo export, empalme tubo de cobre, multicapa y Pex*

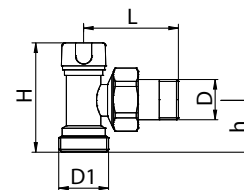

414X connection 24x19

Code	Version	Size (D)	Smooth	€	D1	H	h	l	L	Pack
414X000400		1/2	●	4,71	24x19	49	26	-	47	10



Detentore angolo Eurocono tipo export con cappuccio ottone, attacco tubo rame, multistrato e Pex

414EB

Code	Version	Size (D)	Smooth	€	D1	H	h	l	L	Pack
414E0004B0	-	1/2	●	4,89	3/4	49	26	-	47	10
414E0004BG	O-Ring	1/2	●	5,61	3/4	49	26	-	47	10

*Euroconus angle lockshield-valve light pattern brass cap for copper, multilayer and Pex tube
Detentor acodado Eurocono tipo export, capuchón de latón empalme tubo de cobre, multicapa y Pex*

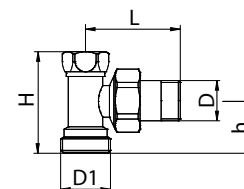

414BX connection 24x19

Code	Version	Size (D)	Smooth	€	D1	H	h	l	L	Pack
414X0004B0		1/2	●	4,89	24x19	49	26	-	47	10



Valvola diritta tipo export, attacco tubo rame, multistrato e Pex

413D

Code	Version	Size (D)	Smooth	€	D1	H	h	l	L	Pack
413DN00300		3/8	●	5,85	-	60	-	-	69	10
413DN0030G	O-Ring	3/8	●	6,57	-	60	-	-	69	10
413DN00400		1/2	●	6,07	-	60	-	-	72	10
413DN0040G	O-Ring	1/2	●	6,89	-	60	-	-	72	10

*Straight radiator valve, light pattern for copper, multilayer and Pex tube
Válvula recta tipo export, empalme tubo de cobre, multicapa y Pex*

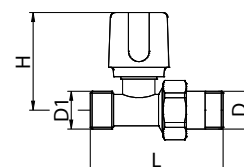



BIANCHI F.lli S.p.a.
Rubinetteria

Finitura: ● Giallo/Yellow
Smooth: ● Cromo/Chrome
● Nichel/Nickel



Detentore diritto
tipo export, attacco
tubo rame, multistrato
e Pex

414D

Code	Version	Size (D)	Smooth	€	D1	H	h	l	L	Pack
414DN00300		3/8	●	5,00	-	30	-	-	69	10
414DN0030G	O-Ring	3/8	●	5,70	-	30	-	-	69	10
414DN00400		1/2	●	5,19	-	30	-	-	72	10
414DN0040G	O-Ring	1/2	●	5,94	-	30	-	-	72	10

Straight lockshield-valve light pattern for copper, multilayer and Pex tube
Detentor recto tipo export, empalme tubo de cobre, multicapa y Pex

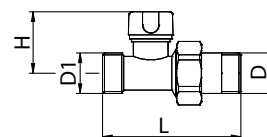

Detentore diritto
tipo export con cap-
puccio ottone, attacco
tubo rame, multistrato
e Pex

*Straight lockshield-
valve light pattern
brass cap for copper,
multilayer and Pex tube*

*Detentor recto
tipo export capuchón
latón, empalme tubo
de cobre, multicapa
y Pex*

414DB

Code	Version	Size (D)	Smooth	€	D1	H	h	l	L	Pack
414DN003B0		3/8	●	5,18	-	30	-	-	69	10
414DN003BG	O-Ring	3/8	●	5,88	-	30	-	-	69	10
414DN004B0		1/2	●	5,44	-	30	-	-	72	10
414DN004BG	O-Ring	1/2	●	6,21	-	30	-	-	72	10

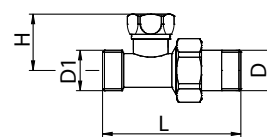

Valvola diritta
Eurocono tipo export,
attacco tubo rame,
multistrato e Pex

413DE

Code	Version	Size (D)	Smooth	€	D1	H	h	l	L	Pack
413DE00400		1/2	●	5,90	3/4	59	-	-	71	10
413DE0040G	O-Ring	1/2	●	6,81	3/4	59	-	-	71	10

Straight radiator Eurocono valve, light pattern, for copper, multilayer and Pex tube
Válvula recta Eurocono tipo export, empalme tubo de cobre, multicapa y Pex

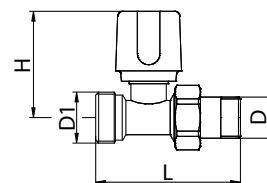

Detentore diritto
Eurocono tipo export,
attacco tubo rame,
multistrato e Pex

414DE

Code	Version	Size (D)	Smooth	€	D1	H	h	l	L	Pack
414DE00400		1/2	●	5,39	3/4	30	-	-	71	10
414DE0040G	O-Ring	1/2	●	6,16	3/4	30	-	-	71	10

Euroconus straight lockshield light pattern for copper, multilayer and Pex tube
Detentor recto Eurocono tipo export, empalme tubo de cobre, multicapa y Pex

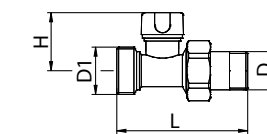

414DX connection 24x19

Code	Version	Size (D)	Smooth	€	D1	H	h	l	L	Pack
414DX00400		1/2	●	5,39	24x19	30	-	-	71	10



Detentore dritto
Eurocono tipo export,
con cappuccio ot-
tone, attacco tubo
rame, multistrato
e Pex

414DEB

Code	Version	Size (D)	Smooth	€	D1	H	h	l	L	Pack
414DE004B0		1/2	●	5,54	3/4	30	-	-	71	10
414DE004BG	O-Ring	1/2	●	6,30	3/4	30	-	-	71	10

Euroconus straight lockshield light pattern brass cap, for copper, multilayer and Pex tube

Detentor recto Eurocono tipo export, capuchón de latón empalme tubo de cobre, multicapa y Pex

414DBX connection 24x19

Code	Version	Size (D)	Smooth	€	D1	H	h	l	L	Pack
414DX004B0		1/2	●	5,54	24x19	30	-	-	71	10

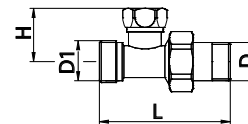

Valvola ad angolo a
saldare tipo export

*Angle radiator valve
copper to copper
connection, light
pattern*

*Válvula acodada tipo
export, empalmes
tubo de cobre para
soldar*

407 S

Code	Version	Size (D)	Smooth	€	D1	H	h	l	L	Pack
407SN32200		3/8x12	●	4,75	-	73	22	-	47	10
407SN3220G	O-Ring	3/8x12	●	5,40	-	73	22	-	47	10
407SN42500		1/2x15	●	5,42	-	73	22	-	47	10
407SN4250G	O-Ring	1/2x15	●	6,20	-	73	22	-	47	10

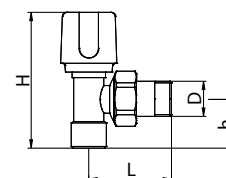

Detentore ad angolo
a saldare tipo export

*Angle lockshield-
valve copper to
copper connection,
light pattern*

*Detentor acodado
tipo export, empalmes
tubo de cobre para
soldar*

408 S

Code	Version	Size (D)	Smooth	€	D1	H	h	l	L	Pack
408SN32200		3/8x12	●	4,14	-	43	21	-	46	10
408SN3220G	O-Ring	3/8x12	●	4,78	-	43	21	-	46	10
408SN42500		1/2x15	●	4,52	-	44	22	-	47	10
408SN4250G	O-Ring	1/2x15	●	5,24	-	44	22	-	47	10

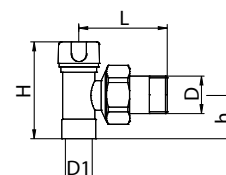

Detentore ad angolo
a saldare tipo export
con cappuccio ottone

408 SB

Code	Version	Size (D)	Smooth	€	D1	H	h	l	L	Pack
408SN3220B		3/8x12	●	4,28	-	43	21	-	46	10
408SN3220BG	O-Ring	3/8x12	●	4,92	-	43	21	-	46	10
408SN4250B		1/2x15	●	4,66	-	44	22	-	47	10
408SN4250BG	O-Ring	1/2x15	●	5,38	-	44	22	-	47	10

Angle lockshield- valve copper to copper connection, light pattern with brass cap

Detentor acodado tipo export, empalmes tubo de cobre para soldar con capuchón latón

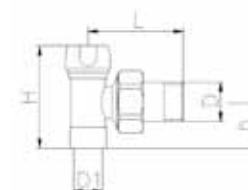

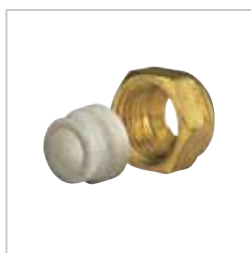

Dado con bicono in P.T.F.E.
Brass nut and P.T.F.E. ring
 Tuerca con bicono de P.T.F.E.

210÷216

Code	Version	Size (D)	Smooth	€	D1	H	I	L	Pack
210004200T		1/2x10	●	1,21	-	-	-	-	50
2100N4200T		1/2x10	●	1,25	-	-	-	-	50
212004220T		1/2x12	●	1,21	-	-	-	-	50
2120N4220T		1/2x12	●	1,25	-	-	-	-	50
214004240T		1/2x14	●	1,21	-	-	-	-	50
2140N4240T		1/2x14	●	1,25	-	-	-	-	50
215004250T		1/2x15	●	1,21	-	-	-	-	50
2150N4250T		1/2x15	●	1,25	-	-	-	-	50
216004260T		1/2x16	●	1,21	-	-	-	-	50
2160N4260T		1/2x16	●	1,25	-	-	-	-	50



Dado da 1/2 con bicono in gomma
Brass nut 1/2 and rubber ring
 Tuerca 1/2 con bicono de goma

210G÷216G

Code	Version	Size (D)	Smooth	€	D1	H	I	L	Pack
210G04200G		1/2x10	●	1,25	-	-	-	-	50
210GN4200G		1/2x10	●	1,29	-	-	-	-	50
212G04220G		1/2x12	●	1,25	-	-	-	-	50
212GN4220G		1/2x12	●	1,29	-	-	-	-	50
214G04240G		1/2x14	●	1,25	-	-	-	-	50
214GN4240G		1/2x14	●	1,29	-	-	-	-	50
215G04250G		1/2x15	●	1,25	-	-	-	-	50
215GN4250G		1/2x15	●	1,29	-	-	-	-	50
216GN4260G		1/2x16	●	2,06	-	-	-	-	50



Dado con bicono in gomma,
 Eurocono
Euroconus brass nut and rubber ring
 Tuerca con bicono de goma
 Eurocono

210E÷218E

Code	Version	Size (D)	Smooth	€	D1	H	I	L	Pack
210EC5200G		3/4x10	●	2,98	-	-	-	-	25
212EC5220G		3/4x12	●	2,98	-	-	-	-	25
214EC5240G		3/4x14	●	2,98	-	-	-	-	25
215EC5250G		3/4x15	●	2,98	-	-	-	-	25
216EC5260G		3/4x16	●	2,98	-	-	-	-	25
218EC5280G		3/4x18	●	2,98	-	-	-	-	25



Dado con bicono in gomma
24x19
24x19 brass nut and rubber ring
 Tuerca con bicono de goma
24x19

214X÷218X connection 24x19

Code	Version	Size (D)	Smooth	€	D1	H	I	L	Pack
214XN02400		14	●	2,52	24x19	-	-	-	50
215XN02500		15	●	2,52	24x19	-	-	-	50
216XN02600		16	●	2,52	24x19	-	-	-	50
218XN02800		18	●	2,52	24x19	-	-	-	50



Adattatore per tubo multistrato
Multilayer tube adaptor
Adaptador para tubo multicapa

219

Code	Version	Size (D)	Smooth	€	D1	H	I	L	Pack
2190000408		1/2x14X2	●	1,80	-	-	-	-	50
219000040B		1/2x16X1,8	●	1,80	-	-	-	-	50
2190000403		1/2x16X2	●	1,80	-	-	-	-	50
2190000405		1/2x16X2,25	●	1,80	-	-	-	-	50
2190N00408		1/2x14X2	●	1,85	-	-	-	-	50
2190N0040B		1/2x16X1,8	●	1,85	-	-	-	-	50
2190N00403		1/2x16X2	●	1,85	-	-	-	-	50
2190N00405		1/2x16X2,25	●	1,85	-	-	-	-	50

219A

ADZ brass

Code	Version	Size (D)	Smooth	€	D1	H	L	M	Pack
21900004A3		1/2x16x2	●	2,13	-	-	-	-	50
2190N004A3		1/2x16x2	●	2,19	-	-	-	-	50



Adattatore per tubo multistrato, in **ADZ**
Multilayer tube adaptor, ADZ brass
Adaptador para tubo multicapa, de ADZ

220A

ADZ brass

Code	Version	Size (D)	Smooth	€	D1	H	L	M	Pack
22000004A2		1/2x15x2,5	●	2,06	-	-	-	-	50
2200N004A2		1/2x15x2,5	●	2,11	-	-	-	-	50



Adattatore per tubo plastica, in **ADZ**
Plastic tube adaptor, ADZ brass
Adaptador para tubo de plastico, de ADZ

219E

Code	Version	Size (D)	Smooth	€	D1	H	I	L	Pack
219E000508		3/4x14X2	●	2,45	-	-	-	-	25
219E00050B		3/4x16X1,8	●	2,45	-	-	-	-	25
219E000503		3/4x16X2	●	2,45	-	-	-	-	25
219E000505		3/4x16X2,25	●	2,45	-	-	-	-	25
219E000506		3/4x17X2	●	2,45	-	-	-	-	25
219E000509		3/4x18X2	●	2,45	-	-	-	-	25
219E00050A		3/4x20X2	●	2,45	-	-	-	-	25
219E00050C		3/4x20X2,25	●	2,45	-	-	-	-	25
219E00050M		3/4x20X2,50	●	2,45	-	-	-	-	25
219EC00508		3/4x14X2	●	2,54	-	-	-	-	25
219EC0050B		3/4x16X1,8	●	2,54	-	-	-	-	25
219EC00503		3/4x16X2	●	2,54	-	-	-	-	25
219EC00505		3/4x16X2,25	●	2,54	-	-	-	-	25
219EC00506		3/4x17X2	●	2,54	-	-	-	-	25
219EC00509		3/4x18X2	●	2,54	-	-	-	-	25
219EC0050A		3/4x20X2	●	2,54	-	-	-	-	25
219EC0050C		3/4x20X2,25	●	2,54	-	-	-	-	25
219EC0050M		3/4x20X2,5	●	2,54	-	-	-	-	25



Adattatore per tubo multistrato tipo Eurocono
Multilayer tube adaptor Euroconus type
Adaptador para tubo multicapa tipo Eurocono



Adattatore per tubo multistrato **24x19**
Multilayer 24x19 tube adaptor
Adaptador 24x19 para tubo multicapa

219X connection 24x19

Code	Version	Size (D)	Smooth	€	D1	H	I	L	Pack
219X002403	-	16x2	●	2,16	24x19	-	-	-	25
219X002409	-	18x2	●	2,16	24x19	-	-	-	25
219X00240N	-	18x2,5	●	2,16	24x19	-	-	-	25
219XN02403	-	16x2	●	2,16	24x19	-	-	-	25
219XN02409	-	18x2	●	2,16	24x19	-	-	-	25
219XN0240N	-	18x2,5	●	2,16	24x19	-	-	-	25



Adattatore per tubo di plastica
Plastic tube adaptor
Adaptador para tubo de plástico

220

Code	Version	Size (D)	Smooth	€	D1	H	I	L	Pack
2200000401		1/2x12X2	●	1,74	-	-	-	-	50
2200000408		1/2x14X2	●	1,74	-	-	-	-	50
2200000402		1/2x15X2,5	●	1,74	-	-	-	-	50
220000040B		1/2x16X1,8	●	1,74	-	-	-	-	50
2200000403		1/2x16X2	●	1,74	-	-	-	-	50
2200000404		1/2x16X2,2	●	1,74	-	-	-	-	50
2200N00401		1/2x12X2	●	1,80	-	-	-	-	50
2200N00408		1/2x14X2	●	1,80	-	-	-	-	50
2200N0040D		1/2x15X2	●	1,80	-	-	-	-	50
2200N00402		1/2x15X2,5	●	1,80	-	-	-	-	50
2200N0040B		1/2x16X1,8	●	1,80	-	-	-	-	50
2200N00403		1/2x16X2	●	1,80	-	-	-	-	50
2200N00404		1/2x16X2,2	●	1,80	-	-	-	-	50



Adattatore per tubo di plastica tipo Eurocono
Plastic tube adaptor Euroconus type
Adaptador para tubo de plástico tipo Eurocono

220E

Code	Version	Size (D)	Smooth	€	D1	H	I	L	Pack
220E000401		3/4x12x2	●	2,36	-	-	-	-	2
220E000408		3/4x14X2	●	2,36	-	-	-	-	25
220E000402		3/4x15X2,5	●	2,36	-	-	-	-	25
220E00040B		3/4x16X1,8	●	2,36	-	-	-	-	25
220E000403		3/4x16X2	●	2,36	-	-	-	-	25
220E000404		3/4x16X2,25	●	2,36	-	-	-	-	25
220E000406		3/4x17X2	●	2,36	-	-	-	-	25
220E000409		3/4x18X2	●	2,36	-	-	-	-	25
220E00040E		3/4x20X1,8	●	2,36	-	-	-	-	25
220E00040A		3/4x20X2	●	2,36	-	-	-	-	25
220E00040C		3/4x20X2,25	●	2,36	-	-	-	-	25
220E00040G		3/4x22X2,5	●	2,36	-	-	-	-	25
220EC00401		3/4x12x2	●	2,43	-	-	-	-	25
220EC00408		3/4x14X2	●	2,43	-	-	-	-	25
220EC00402		3/4x15X2,5	●	2,43	-	-	-	-	25
220EC0040B		3/4x16X1,8	●	2,43	-	-	-	-	25
220EC00403		3/4x16X2	●	2,43	-	-	-	-	25
220EC00404		3/4x16X2,25	●	2,43	-	-	-	-	25
220EC00406		3/4x17X2	●	2,43	-	-	-	-	25
220EC00409		3/4x18X2	●	2,43	-	-	-	-	25
220EC0040E		3/4x20X1,8	●	2,43	-	-	-	-	25
220EC0040A		3/4x20X2	●	2,43	-	-	-	-	25
220EC0040C		3/4x20X2,25	●	2,43	-	-	-	-	25



Adattatore per tubo
PVC **24x19**

Plastic **24x19** tube
PVC adaptor

Adaptador para tubo
PVC **24x19**

220X connection 24x19

Code	Version	Size (D)	Smooth	€	D1	H	I	L	Pack
220X002402	-	15x2,5	●	2,11	-	-	-	-	25
220X002403	-	16x2	●	2,11	-	-	-	-	25
220X002409	-	18x2	●	2,11	-	-	-	-	25
220X00240N	-	18x2,5	●	2,11	-	-	-	-	25
220XN02402	-	15x2,5	●	2,11	-	-	-	-	25
220XN02403	-	16x2	●	2,11	-	-	-	-	25
220XN02409	-	18x2	●	2,11	-	-	-	-	25
220XN0240N	-	18x2,5	●	2,11	-	-	-	-	25



Raccordo curvo per
termosifone

Elbow coupling for
radiator unit

Codo de unión para
radiador

415

Code	Version	Size (D)	Smooth	€	D1	H	h	I	L	Pack
4150000300		3/8	●	3,17	-	17	-	-	45	30
4150000400		1/2	●	3,70	-	20	-	-	51	20
4150000500		3/4	●	5,85	-	24	-	-	60	10
4150000600		1"	●	10,13	-	33	-	-	69	5
4150C00300		3/8	●	3,22	-	17	-	-	45	30
4150C00400		1/2	●	3,81	-	20	-	-	51	20
4150C00500		3/4	●	6,04	-	24	-	-	60	10
4150C00600		1"	●	10,44	-	33	-	-	69	5

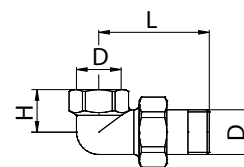

Raccordo curvo per
termosifone, tenuta
OR

Elbow coupling for
radiator unit with
O-Ring

Codo de unión para
radiador,
empaquetadura de
anillo

415B

Code	Version	Size (D)	Smooth	€	D1	H	h	I	L	Pack
415B000300		3/8	●	3,22	-	17	-	-	45	30
415B000400		1/2	●	3,87	-	20	-	-	51	20
415B000500		3/4	●	5,88	-	24	-	-	60	10
415B000600		1"	●	9,78	-	33	-	-	69	5
415B000700		1" 1/4	●	15,53	-	33	-	-	72	4
415B000800		1" 1/2	●	28,13	-	41	-	-	91	2
415B000900		2"	●	50,40	-	69	-	-	118	1
415BC00300		3/8	●	3,47	-	17	-	-	45	30
415BC00400		1/2	●	4,13	-	20	-	-	51	20
415BC00500		3/4	●	6,34	-	24	-	-	60	10
415BC00600		1"	●	10,26	-	33	-	-	69	5
415BC00700		1" 1/4	●	16,31	-	33	-	-	72	4
415BC00800		1" 1/2	●	29,53	-	41	-	-	91	2
415BC00900		2"	●	52,92	-	69	-	-	118	1

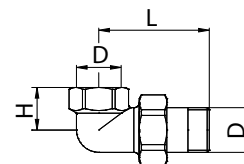



Raccordo diritto per termosifone
Straight coupling for radiator unit
Empalme recto para radiador

416

Code	Version	Size (D)	Smooth	€	D1	H	h	l	L	Pack
416000300		3/8	●	2,65	-	-	-	-	43	50
416000400		1/2	●	2,86	-	-	-	-	45	30
416000500		3/4	●	4,48	-	-	-	-	53	15
416000600		1"	●	7,47	-	-	-	-	59	10
4160C00300		3/8	●	2,77	-	-	-	-	43	50
4160C00400		1/2	●	3,00	-	-	-	-	45	30
4160C00500		3/4	●	4,77	-	-	-	-	53	15
4160C00600		1"	●	7,98	-	-	-	-	59	10

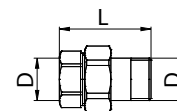

Raccordo diritto per termosifone, tenuta OR
Straight coupling for radiator unit with O-Ring
Empalme recto para radiador, empaquetadura de anillo

416B

Code	Version	Size (D)	Smooth	€	D1	H	h	l	L	Pack
416B000300		3/8	●	2,70	-	-	-	-	43	50
416B000400		1/2	●	2,74	-	-	-	-	45	30
416B000500		3/4	●	4,53	-	-	-	-	53	15
416B000600		1"	●	7,62	-	-	-	-	59	10
416B000700		1" 1/4	●	11,68	-	-	-	-	66	6
416B000800		1" 1/2	●	20,89	-	-	-	-	76	4
416B000900		2"	●	36,88	-	-	-	-	98	1
416BC00300		3/8	●	2,82	-	-	-	-	43	50
416BC00400		1/2	●	2,91	-	-	-	-	45	30
416BC00500		3/4	●	4,81	-	-	-	-	53	15
416BC00600		1"	●	8,07	-	-	-	-	59	10
416BC00700		1" 1/4	●	12,09	-	-	-	-	66	6
416BC00800		1" 1/2	●	22,00	-	-	-	-	76	4
416BC00900		2"	●	38,56	-	-	-	-	98	1

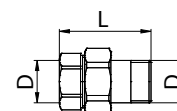

Raccordo diritto M-M per collettore a 3 pezzi, tenuta OR
Three pieces male-male straight coupling with O-Ring
Empalme recto macho-macho para tubo de distribución, empaquetadura de anillo

4161

Code	Version	Size (D)	Smooth	€	D1	H	h	l	L	Pack
4161C0050G		3/4	●	7,33	-	-	-	-	56	15
4161C0060G		1"	●	9,53	-	-	-	-	67	10

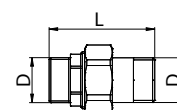

Tappo radiatore con valvola di sfogo disponibile con filetto destro (417D) o sinistro (417S)

417

Code	Version	Size (D)	Smooth	€	D1	H	h	l	L	Pack
417D000600	Dx/Right	1"	●	7,46	-	-	-	-	29	10
417D000700	Dx/Right	1" 1/4	●	8,57	-	-	-	-	33	10
417S000600	Sx/Left	1"	●	7,46	-	-	-	-	29	10
417S000700	Sx/Left	1" 1/4	●	8,57	-	-	-	-	33	10

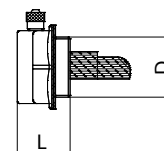

Radiator plug with discharge valve available with right (417D) or left thread (417S)

Tapon para radiador con valvula de desahogo disponible derecho (417D) e izquierdo (417S)



Valvolina a sfriato aria cromata con OR, maniglia in ottone

Air discharge valve with OR and brass handle

Válvula de desahogo de aire cromada con OR, manija de latón

418

Code	Version	Size (D)	Smooth	€	D1	H	h	l	L	Pack
4180C00100		1/8	●	1,09	-	26	-	-	-	100
4180C00200		1/4	●	1,10	-	30	-	-	-	100
4180C00300		3/8	●	1,28	-	31	-	-	-	100
4180C00400		1/2	●	1,97	-	25	-	-	-	50

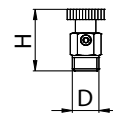

Valvolina sfriato aria cromata, maniglia in plastica

Air discharge valve with plastic handle

Válvula de desahogo de aire cromada, manija de plástico

418P

Code	Version	Size (D)	Smooth	€	D1	H	h	l	L	Pack
4180C0010P		1/8	●	0,68	-	28	-	-	-	100
4180C0020P		1/4	●	0,76	-	28	-	-	-	100
4180C0030P		3/8	●	0,98	-	28	-	-	-	100
4180C0040P		1/2	●	1,34	-	28	-	-	-	50

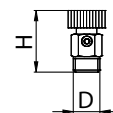

Valvolina a sfriato aria cromata con anello in PTFE, maniglia in plastica

Air discharge valve with PTFE sealing and plastic handle

Válvula de desahogo de aire cromada con anillo en PTFE, manija de plástico

418T

Code	Version	Size (D)	Smooth	€	D1	H	h	l	L	Pack
4180C0020T		1/4	●	1,08	-	33	-	-	-	100
4180C0030T		3/8	●	1,38	-	33	-	-	-	100

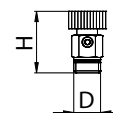

Valvola sfriato automatica

Automatic air discharge valve

Válvula de desahogo automática

419

Code	Version	Size (D)	Smooth	€	D1	H	h	l	L	Pack
4190000300		3/8	●	5,34	-	70	-	-	-	24
4190000400		1/2	●	5,42	-	70	-	-	-	24
4190N00300		3/8	●	6,20	-	70	-	-	-	24
4190N00400		1/2	●	6,71	-	70	-	-	-	24

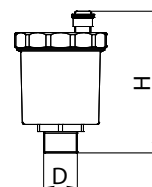

Valvola a sfriato automatica con attacco laterale

Automatic air discharge valve with side connection

Purgador de vaciado automatico con conexion lateral

419B

Code	Version	Size (D)	Smooth	€	D1	H	h	l	L	Pack
419B000300		3/8	●	6,77	-	61	-	-	-	24
419B000400		1/2	●	6,77	-	61	-	-	-	24
419BN00300		3/8	●	7,18	-	61	-	-	-	24
419BN00400		1/2	●	7,18	-	61	-	-	-	24

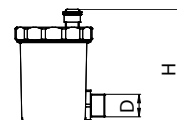



BIANCHI F.lli S.p.a.
Rubineria

Finitura: ● Giallo/Yellow
Smooth: ● Cromo/Chrome
● Nichel/Nickel



Valvola a sfiato
automatica con
scarico laterale
*Automatic air
discharge valve with
side drain*
*Purgador de vaciado
automatico con
conexion lateral*

419L

Code	Version	Size (D)	Smooth	€	D1	H	h	l	L	Pack
419L000300		3/8	●	6,06	-	58	-	-	-	25
419L000400		1/2	●	6,29	-	58	-	-	-	25
419LN00300		3/8	●	6,11	-	58	-	-	-	25
419LN00400		1/2	●	6,34	-	58	-	-	-	25

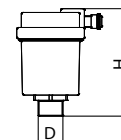

Valvola sfiato
automatica per
impianti **solari**
*Automatic air
discharge valve
for solar systems*
*Válvula de desahogo
automática para
sistemas de solar*

419 S

Code	Version	Size (D)	Smooth	€	D1	H	h	l	L	Pack
419S000300		3/8	●	17,89	-	70	-	-	-	24
419S000400		1/2	●	17,89	-	70	-	-	-	24

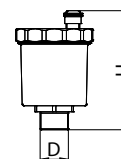

Valvola d'isolamento
Mini isolated valve
Válvula de aislamiento

420

Code	Version	Size (D)	Smooth	€	D1	H	h	l	L	Pack
4200030300		3/8X3/8	●	1,18	3/8	23	-	-	-	50
4200040300		1/2X3/8	●	1,94	3/8	24	-	-	-	50
4200040400		1/2X1/2	●	1,94	1/2	25	-	-	-	50

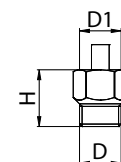

Valvola di sicurezza
attacco maschio
*Safety valve, male
connection*
*Válvula de seguridad,
empalme macho*

447

Code	Version	Size (D)	Smooth	€	D1	H	h	l	L	Pack
4470000401	1,8 Bar	1/2	●	5,83	-	65	22	-	25	10
44700004A2	2 Bar	1/2	●	5,83	-	65	22	-	25	10
4470000402	2,5 Bar	1/2	●	5,83	-	65	22	-	25	10
4470000403	3 Bar	1/2	●	5,83	-	65	22	-	25	10
4470000404	4 Bar	1/2	●	5,83	-	65	22	-	25	10
4470000405	5 Bar	1/2	●	5,83	-	65	22	-	25	10
4470000406	6 Bar	1/2	●	5,83	-	65	22	-	25	10
4470000407	7 Bar	1/2	●	5,83	-	65	22	-	25	10
4474000408	8 Bar	1/2	●	10,11	-	80	25	-	24	10
4474000410	10 Bar	1/2	●	10,11	-	80	25	-	24	10
4470000501	1,8 Bar	3/4	●	10,11	-	88	31	-	32	10
4470000502	2,5 Bar	3/4	●	10,11	-	88	31	-	32	10
4470000503	3 Bar	3/4	●	10,11	-	88	31	-	32	10
4470000504	4 Bar	3/4	●	10,11	-	88	31	-	32	10
4470000505	5 Bar	3/4	●	10,11	-	88	31	-	32	10
4470000506	6 Bar	3/4	●	10,11	-	88	31	-	32	10
4470000507	7 Bar	3/4	●	10,11	-	88	31	-	32	10
4470000508	8 Bar	3/4	●	12,55	-	90	34	-	32	10
4470000510	10 Bar	3/4	●	12,55	-	90	34	-	32	10

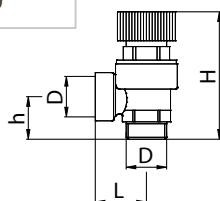



Valvola di sicurezza
attacco femmina
Safety valve, female
connection
Válvula de seguridad,
empalme hembra

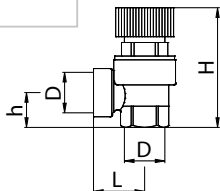

447B

Code	Version	Size (D)	Smooth	€	D1	H	h	l	L	Pack
447B000401	1,8 Bar	1/2	●	5,68	-	62	18	-	25	10
447B0004A2	2 Bar	1/2	●	5,68	-	62	18	-	25	10
447B000402	2,5 Bar	1/2	●	5,68	-	62	18	-	25	10
447B000403	3 Bar	1/2	●	5,68	-	62	18	-	25	10
447B000404	4 Bar	1/2	●	5,68	-	62	18	-	25	10
447B000405	5 Bar	1/2	●	5,68	-	62	18	-	25	10
447B000406	6 Bar	1/2	●	5,68	-	62	18	-	25	10
447B000407	7 Bar	1/2	●	5,68	-	62	18	-	25	10
4474B00408	8 Bar	1/2	●	9,73	-	70	18	-	25	10
4474B00410	10 Bar	1/2	●	9,73	-	70	18	-	25	10
447B000501	1,8 Bar	3/4	●	9,73	-	80	24	-	30	10
447B0005A2	2 Bar	3/4	●	9,73	-	80	24	-	30	10
447B000502	2,5 Bar	3/4	●	9,73	-	80	24	-	30	10
447B000503	3 Bar	3/4	●	9,73	-	80	24	-	30	10
447B000504	4 Bar	3/4	●	9,73	-	80	24	-	30	10
447B000505	5 Bar	3/4	●	9,73	-	80	24	-	30	10
447B000506	6 Bar	3/4	●	9,73	-	80	24	-	30	10
447B000507	7 Bar	3/4	●	9,73	-	80	24	-	30	10
447B000508	8 Bar	3/4	●	12,10	-	82	25	-	32	10
447B000510	10 Bar	3/4	●	12,10	-	82	25	-	32	10
447B000601	1,8 Bar	1"	●	22,97	-	112	30	-	38	2
447B0006A2	2 Bar	1"	●	22,97	-	112	30	-	38	2
447B000602	2,5 Bar	1"	●	22,97	-	112	30	-	38	2
447B000603	3 Bar	1"	●	22,97	-	112	30	-	38	2
447B000604	4 Bar	1"	●	22,97	-	112	30	-	38	2
447B000605	5 Bar	1"	●	22,97	-	112	30	-	38	2
447B000606	6 Bar	1"	●	22,97	-	112	30	-	38	2
447B000607	7 Bar	1"	●	22,97	-	112	30	-	38	2
447B000608	8 Bar	1"	●	22,97	-	112	30	-	38	2
447B000610	10 Bar	1"	●	22,97	-	112	30	-	38	2
447B0007A2	2 Bar	1" 1/4	●	72,72	-	191	45	-	54	1
447B000702	2,5 Bar	1" 1/4	●	72,72	-	191	45	-	54	1
447B000703	3 Bar	1" 1/4	●	72,72	-	191	45	-	54	1
447B000704	4 Bar	1" 1/4	●	72,72	-	191	45	-	54	1
447B000705	5 Bar	1" 1/4	●	72,72	-	191	45	-	54	1
447B000706	6 Bar	1" 1/4	●	72,72	-	191	45	-	54	1
447B000707	7 Bar	1" 1/4	●	72,72	-	191	45	-	54	1
447B000708	8 Bar	1" 1/4	●	72,72	-	191	45	-	54	1
447B000710	10 Bar	1" 1/4	●	72,72	-	191	45	-	54	1
447B000802	2,5 Bar	1" 1/2	●	92,25	-	207	47	-	60	1
447B000803	3 Bar	1" 1/2	●	92,25	-	207	47	-	60	1
447B000804	4 Bar	1" 1/2	●	92,25	-	207	47	-	60	1
447B000806	6 Bar	1" 1/2	●	92,25	-	207	47	-	60	1
447B000810	10 Bar	1" 1/2	●	92,25	-	207	47	-	60	1
447B000903	3 Bar	2"	●	128,95	-	233	60	-	72	1
447B000906	6 Bar	2"	●	128,95	-	233	60	-	72	1
447B000910	10 Bar	2"	●	128,95	-	233	60	-	72	1

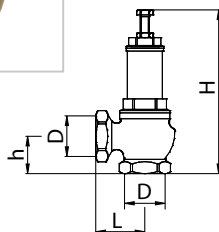

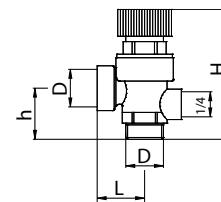

Valvola di sicurezza
 attacco maschio
 con attacco per
 manometro
*Safety valve male
 connection, with
 manometer connection*
*Válvula de seguridad
 empalme macho
 con empalme para
 manómetro*

447C

Code	Version	Size (D)	Smooth	€	D1	H	h	l	L	Pack
447C000401	1,8 Bar	1/2	●	7,18	-	65	22	-	25	10
447C0004A2	2 Bar	1/2	●	7,18	-	65	22	-	25	10
447C000402	2,5 Bar	1/2	●	7,18	-	65	22	-	25	10
447C000403	3 Bar	1/2	●	7,18	-	65	22	-	25	10
447C000404	4 Bar	1/2	●	7,18	-	65	22	-	25	10
447C000406	6 Bar	1/2	●	7,18	-	65	22	-	25	10

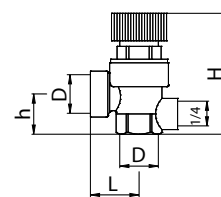

Valvola di sicurezza
 attacco femmina
 con attacco per
 manometro
*Safety valve female
 connection, with ma-
 nometer connection*
*Válvula de seguri-
 dad hembra con
 empalme para
 manómetro*

447D

Code	Version	Size (D)	Smooth	€	D1	H	h	l	L	Pack
447D000401	1,8 Bar	1/2	●	6,75	-	62	18	-	25	10
447D000402	2,5 Bar	1/2	●	6,75	-	62	18	-	25	10
447D000403	3 Bar	1/2	●	6,75	-	62	18	-	25	10
447D000404	4 Bar	1/2	●	6,75	-	62	18	-	25	10
447D000406	6 Bar	1/2	●	6,75	-	62	18	-	25	10

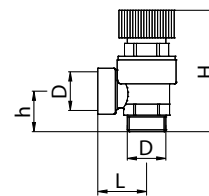

Valvola di sicurezza
 per impianti **solari**
 attacco maschio
*Safety valve for
 solar systems,
 male connection*
*Válvula de seguridad
 para sistemas de solar
 empalme macho*

4473

Code	Version	Size (D)	Smooth	€	D1	H	h	l	L	Pack
4473000404	4 Bar	1/2	●	11,61	-	77	33	-	35	10
4473000406	6 Bar	1/2	●	11,61	-	77	33	-	35	10

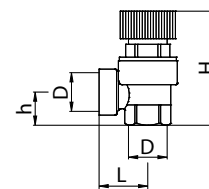

Valvola di sicurezza
 per impianti **solari**
 attacco femmina
*Safety valve for
 solar systems,
 female connection*
*Válvula de seguridad
 para sistemas de solar
 empalme hembra*

4473B

Code	Version	Size (D)	Smooth	€	D1	H	h	l	L	Pack
4473B00404	4 Bar	1/2	●	10,84	-	69	24	-	35	10
4473B00406	6 Bar	1/2	●	10,84	-	69	24	-	35	10



Manometro Ø 63
attacco posteriore
*Manometer Ø 63
back connection*
*Manómetro Ø 63
empalme posterior*

448

Code	Version	Size (D)	Smooth	€	D1	H	h	l	L	Pack
4480000204	0-4 Bar	1/4	●	7,57	63	-	-	-	-	1
4480000206	0-6 Bar	1/4	●	7,57	63	-	-	-	-	1
4480000210	0-10 Bar	1/4	●	7,57	63	-	-	-	-	1

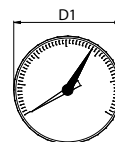

448T-448TV

Code	Version	Size (D)	Smooth	€	D1	H	h	l	L	Pack
448T000406		1/2	●	21,06	80	-	-	-	-	1

Termomanometro attacco posteriore - *Thermomanometer back connection* - *Termomanómetro empalme posterior*

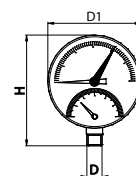

448TV00406		1/2	●	32,86	80	109	-	-	-	1
------------	--	-----	---	--------------	----	-----	---	---	---	---

Termomanometro attacco verticale - *Thermomanometer vertical connection* - *Termomanómetro empalme vertical*



Manometro con
attacco verticale
*Manometer with
vertical connection*
*Manómetro con
empalme vertical*

448V

Code	Version	Size (D)	Smooth	€	D1	H	h	l	L	Pack
448V000204	0-4 Bar	1/4	●	7,57	63	85	-	-	-	1
448V000206	0-6 Bar	1/4	●	7,57	63	85	-	-	-	1
448V000210	0-10 Bar	1/4	●	7,57	63	85	-	-	-	1
448V000306	0-6 Bar	3/8	●	14,66	80	109	-	-	-	1
448V000310	0-10 Bar	3/8	●	14,66	80	109	-	-	-	1

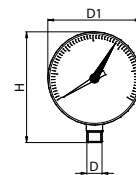

Termometro bimetallico
Ø 40mm. Scala:
0°- 80°C / 32°-170°F
*Bimetallic thermometer
Ø 40mm. Scale:
0°- 80°C / 32°-170°F*
*Termómetro bimetalico
Ø 40mm. Escala:
0°- 80°C / 32°-170°F*

448B

Code	Version	Size (D)	Smooth	€	D1	H	h	l	L	Pack
448B000000		3/8	●	8,13	40	-	-	-	-	1

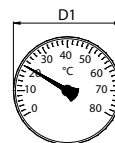

Alimentatore
automatico con
manometro
*Automatic valve
with manometer*
*Alimentador
automático con
manómetro*

449

Code	Version	Size (D)	Smooth	€	D1	H	h	l	L	Pack
4490000400		1/2	●	39,01	-	119	-	-	137	1

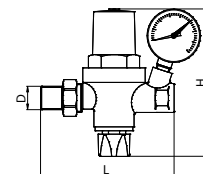



BIANCHI F.lli S.p.a.
Rubineria

Finitura: ● Cromo/Chrome
Smooth: ○ Bianco-Cromo/White-Chrome



Valvola ad angolo termo-
statizzabile, attacco tubo
rame, multistrato e Pex

*Angle thermostatic
radiator valve for copper,
multilayer and Pex tube*

*Válvula acodada
termostática empalme
tubo de cobre,
multicapa y Pex*

409TK

Code	Version	Size (D)	Smooth	€	D1	H	h	l	L	Pack
409TK003B0		3/8	○	16,74	-	85	28,5	-	55,5	1
409TK003C0		3/8	●	16,74	-	85	28,5	-	55,5	1
409TK004B0		1/2	○	16,74	-	85	28,5	-	55,5	1
409TK004C0		1/2	●	16,74	-	85	28,5	-	55,5	1

Finitura / Smooth: ● Cromo/Chrome
○ Bianco-Cromo/White-Chrome

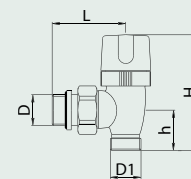

Detentore ad angolo
attacco tubo rame,
multistrato e Pex

*Angle lockshield valve
for copper, multilayer
and Pex tube*

*Detentor acodado
empalme tubo de cobre,
multicapa y Pex*

410K

Code	Version	Size (D)	Smooth	€	D1	H	h	l	L	Pack
410K0003B0		3/8	○	15,64	-	63	28,5	-	55,5	1
410K0003C0		3/8	●	15,64	-	63	28,5	-	55,5	1
410K0004B0		1/2	○	15,64	-	63	28,5	-	55,5	1
410K0004C0		1/2	●	15,64	-	63	28,5	-	55,5	1

Finitura / Smooth: ● Cromo/Chrome
○ Bianco-Cromo/White-Chrome

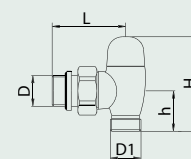

Valvola diritta termo-
statizzabile, attacco
tubo rame, multistrato
e Pex

*Straight thermostatic
radiator valve for copper,
multilayer and Pex tube*

*Válvula recta termo-
stática empalme tubo de
cobre, multicapa y Pex*

411TK

Code	Version	Size (D)	Smooth	€	D1	H	h	l	L	Pack
411TK003B0		3/8	○	17,59	-	62	-	-	71	1
411TK003C0		3/8	●	17,59	-	62	-	-	71	1
411TK004B0		1/2	○	17,59	-	62	-	-	73	1
411TK004C0		1/2	●	17,59	-	62	-	-	73	1

Finitura / Smooth: ● Cromo/Chrome
○ Bianco-Cromo/White-Chrome

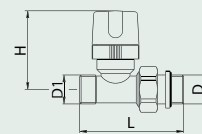

Detentore diritto
attacco tubo rame,
multistrato e Pex

*Straight lockshield
valve for copper,
multilayer and Pex tube*

*Detentor recto
empalme tubo de
cobre, multicapa y Pex*

412K

Code	Version	Size (D)	Smooth	€	D1	H	h	l	L	Pack
412K0003B0		3/8	○	15,87	-	40	-	-	71	1
412K0003C0		3/8	●	15,87	-	40	-	-	71	1
412K0004B0		1/2	○	15,87	-	40	-	-	73	1
412K0004C0		1/2	●	15,87	-	40	-	-	73	1

Finitura / Smooth: ● Cromo/Chrome
○ Bianco-Cromo/White-Chrome

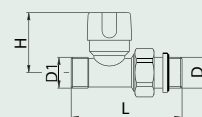

Dado lucido con
bicono in gomma

*Brass nut and
rubber ring polish
chrome finishing*

*Tuerca cromada
brillante y junta
tórica goma*

210L÷215L

Code	Version	Size (D)	Smooth	€	D1	H	h	l	L	Pack
210LC4200G	Chrome	1/2 x 10	L	2,03	-	-	-	-	-	50
212LC4220G	Chrome	1/2 x 12	L	2,03	-	-	-	-	-	50
214LC4240G	Chrome	1/2 x 14	L	2,03	-	-	-	-	-	50
215LC4250G	Chrome	1/2 x 15	L	2,03	-	-	-	-	-	50



Valvola ad angolo, attacco tubo rame, multistrato e Pex
Angle radiator valve for copper, multilayer and Pex tube
Válvula acodada empalme tubo de cobre, multicapa y Pex

4409W

Code	Version	Size (D)	Smooth	€	D1	H	h	l	L	Pack
4409W003B0		3/8	○	20,20	-	-	-	-	-	1
4409W003C0		3/8	●	20,20	-	-	-	-	-	1
4409W004B0		1/2	○	20,20	-	-	-	-	-	1
4409W004C0		1/2	●	20,20	-	-	-	-	-	1

Finitura / Smooth: ● Cromo/Chrome
○ Bianco-Cromo/white-Chrome

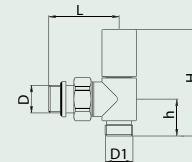

Detentore ad angolo attacco tubo rame, multistrato e Pex
Angle lockshield valve for copper, multilayer and Pex tube
Detentor acodado empalme tubo de cobre, multicapa y Pex

4410W

Code	Version	Size (D)	Smooth	€	D1	H	h	l	L	Pack
4410W003B0		3/8	○	18,60	-	-	-	-	-	1
4410W003C0		3/8	●	18,60	-	-	-	-	-	1
4410W004B0		1/2	○	18,60	-	-	-	-	-	1
4410W004C0		1/2	●	18,60	-	-	-	-	-	1

Finitura / Smooth: ● Cromo/Chrome
○ Bianco-Cromo/white-Chrome

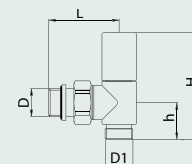

Valvola radiatore reversa, attacco tubo rame, multistrato e Pex
Inverse radiator valve for copper, multilayer and Pex tube
Válvula empalme reversa tubo de cobre, multicapa y Pex

4417W

Code	Version	Size (D)	Smooth	€	D1	H	h	l	L	Pack
4417W004B0		1/2	○	20,20	-	-	-	-	-	1
4417W004C0		1/2	●	20,20	-	-	-	-	-	1

Finitura / Smooth: ● Cromo/Chrome
○ Bianco-Cromo/white-Chrome

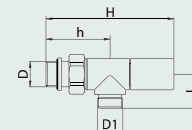

Adattatore lucido per tubo multistrato
Multilayer tube adaptor polish chrome finishing
Adaptador lúcido para tubo multicapa

219L

Code	Version	Size (D)	Smooth	€	D1	H	h	l	L	Pack
219LC00403		16 x 2	L	2,51	-	-	-	-	-	50
219LC00405		16 x 2,25	L	2,51	-	-	-	-	-	50
219LC00408		14 x 2	L	2,51	-	-	-	-	-	50



BIANCHI F.lli S.p.
Rubinetteria

Finitura: ● Giallo/Yellow
Smooth: ● Cromo/Chrome
● Nichel/Nikel

L'ultima lettera
del codice indica
il tipo e il colore
della maniglia

A ROSSA
D BLU
O BIANCA



Valvola a 2 vie
per Fan Coil
*2 ways Fan Coil
valve*
*Válvula de 2 vías
para Fan Coil*

662

Code	Version	Size (D)	Smooth	€	D1	H	h	l	L	M	Pack
662V000400		1/2	●	11,47	-	48	-	-	53	-	4
662V000500		3/4	●	11,64	-	48	-	-	56	-	4
662V000600		1"	●	15,42	-	52	-	-	65	-	4

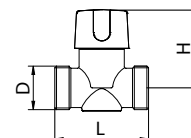

Valvola a 3 vie
per Fan Coil
*3 ways Fan Coil
valve*
*Válvula de 3 vías
para Fan Coil*

663

Code	Version	Size (D)	Smooth	€	D1	H	h	l	L	M	Pack
663V000400		1/2	●	19,25	-	78	48	-	53	-	4
663V000500		3/4	●	19,72	-	76	48	-	56	-	4
663V000600		1"	●	22,16	-	87	52	-	65	-	4

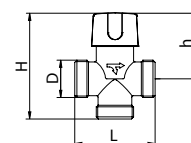

Valvola a 4 vie
per Fan Coil
*4 ways Fan Coil
valve*
*Válvula de 4
vías para Fan
Coil*

664

Code	Version	Size (D)	Smooth	€	D1	H	h	l	L	M	Pack
664V000400		1/2	●	24,94	-	102	48	36	53	-	4
664V000500		3/4	●	25,45	-	116	48	50	56	-	4
664V000600		1"	●	28,74	-	124	52	50	65	-	4

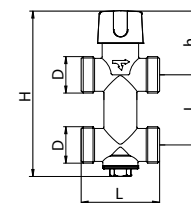



Termostato ambiente elettromeccanico senza spia

Mechanical thermostat for wall installation, swithing contact

Termostato medio ambiente electromecanico sim luz

3207

Code	Version	Size (D)	Smooth	€	D1	H	h	l	L	Pack
3207000000		-	-	15,10	-	-	-	-	-	1



Termostato ambiente elettromeccanico con spia ON/OFF

Mechanical thermostat for wall installation, swithing contact with lamp, swithc ON/OFF

Termostato medio ambiente electromecanico con indicador ON/OFF

3209

Code	Version	Size (D)	Smooth	€	D1	H	h	l	L	Pack
3209000000		-	-	20,96	-	-	-	-	-	1



Termostato ambiente elettromeccanico con spia

Mechanical thermostat for wall installation, swithing contact with lamp

Termostato de ambiente electromecanico con luz

3210

Code	Version	Size (D)	Smooth	€	D1	H	h	l	L	Pack
3210000000		-	-	17,48	-	-	-	-	-	1



Termostato ambiente touch screen

Digital touch screen thermostat

Termostato de ambiente pantalla táctil

3211

Code	Version	Size (D)	Smooth	€	D1	H	h	l	L	Pack
3211000000		-	-	90,59	-	-	-	-	-	1



Cronotermostato a due temperature impostabili

Chronothermostat with two temperature setting

Cronotermostato de ambiente ajustable a dos temperaturas

3215

Code	Version	Size (D)	Smooth	€	D1	H	h	l	L	Pack
3215000000		-	-	94,14	-	-	-	-	-	1



Cronotermostato elettromeccanico settimanale e giornaliero

Chronothermostat with daily and weakly setting

Cronotermostato electromecanico semanal y diario

3217

Code	Version	Size (D)	Smooth	€	D1	H	h	l	L	Pack
3217000000		-	-	120,78	-	-	-	-	-	1



Schema di applicazione valvole per radiatori

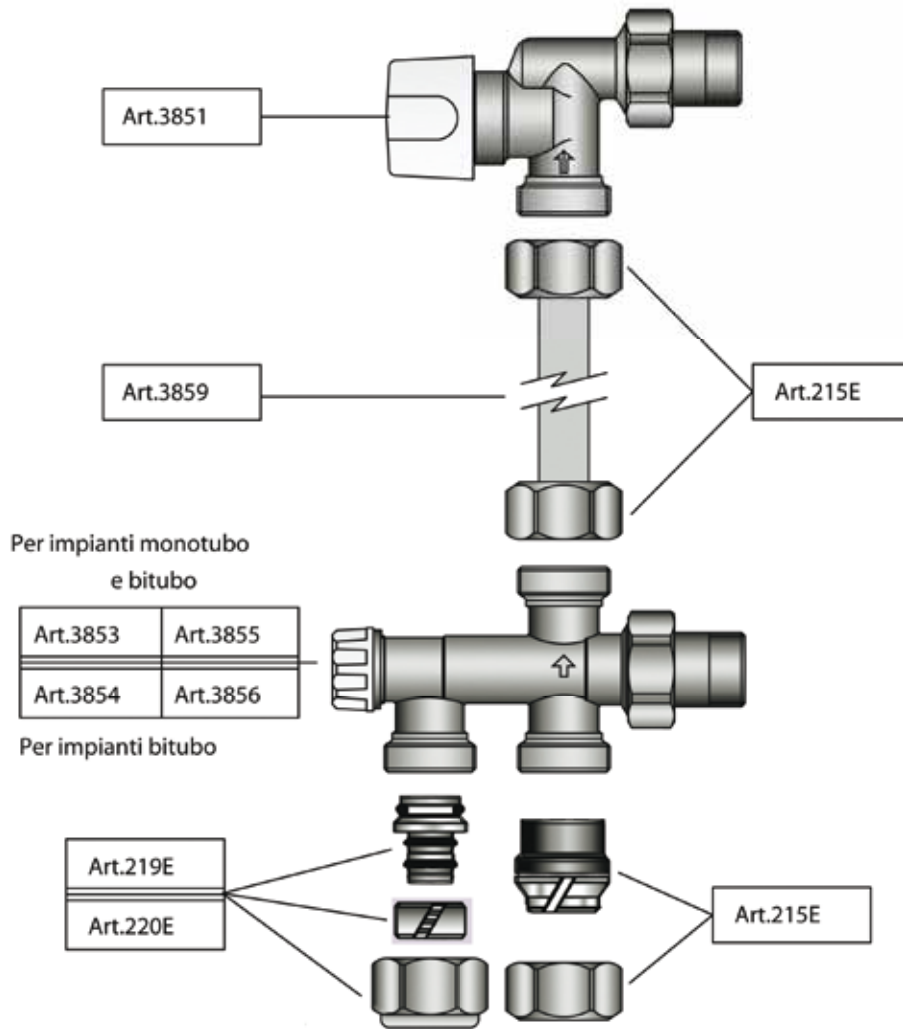

Tipi di impianto

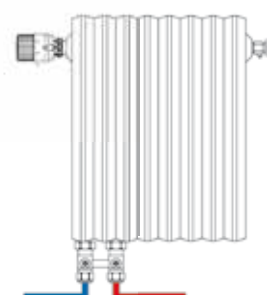
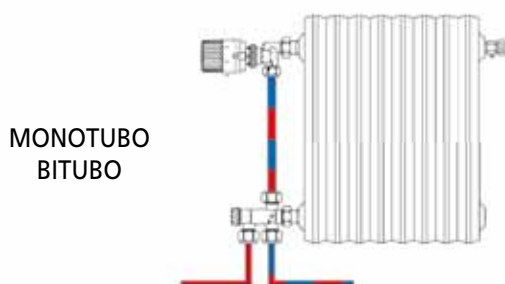
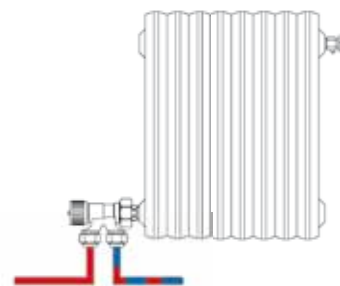
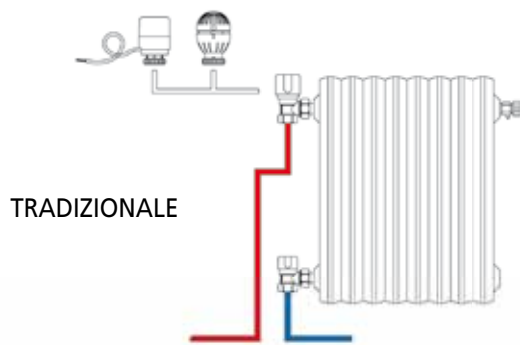



210

Dado con bicono in P.T.F.E. Ø 10 - 12 - 14 - 15 - 16
Brass nut and P.T.F.E. ring
Tuerca con bicono de P.T.F.E.

210G

Dado con bicono in gomma Ø 10 - 12 - 14 - 15 - 16
Brass nut and rubber ring
Tuerca con bicono de goma

219

Adattatore per tubo multistrato Ø 14x2 - 16x1,8 - 16x2
Multilayer tube adaptor Ø 16x2,25
Adaptador para tubo multicapa

220

Adattatore per tubo di plastica Ø 12x2 - 14x2 - 15x2,5
Plastic tube adaptor Ø 16x2 - 16x2,2 - 16,1,8
Adaptador para tubo de plástico

210E

Dado con bicono in gomma tipo Eurocono
Euroconus brass nut and rubber ring
Tuerca con bicono de goma tipo Eurocono
Ø 10x3/4 - 12x3/4 - 14x3/4 - 15x3/4 - 16x3/4 - 18x3/4

219E

Adattatore per tubo multistrato tipo Eurocono
Multilayer tube adaptor Euroconus type
Adaptador para tubo multicapa tipo Eurocono
Ø 14x2x3/4 - 16x1,8x3/4 - 16x2x3/4 - 16x2,25x3/4 - 17x2x3/4
Ø 18x2x3/4 - 20x2x3/4 - 20x2,25x3/4 - 20x2,5x3/4

220E

Adattatore per tubo di plastica tipo Eurocono
Plastic tube adaptor Euroconus type
Adaptador para tubo de plástico tipo Eurocono
Ø 12x2x3/4 - 14x2x3/4 - 15x2,5x3/4 - 16x1,8x3/4
Ø 16x2,25x3/4 - 17x2x3/4 - 18x2x3/4 - 20x1,8x3/4
Ø 20x2x3/4 - 20x2,25x3/4 - 22x2,25x3/4

214X

Dado con bicono in gomma 24x19 Ø 14 - 15 - 16 - 18
24x19 brass nut and rubber ring
Tuerca con tubo de goma 24x19

219X

Adattatore per tubo multistrato 24x19 Ø 16x2 - 18x2
Multilayer 24x19 tube adaptor Ø 18x2,5
Adaptador para tubo multicapa 24x19

220X

Adattatore per tubo PVC 24x19 Ø 15x2,5 - 16x2
Plastic 24x19 tube PVC adaptor Ø 18x2 - 18x2,5
Adaptador para tubo PVC 24x19

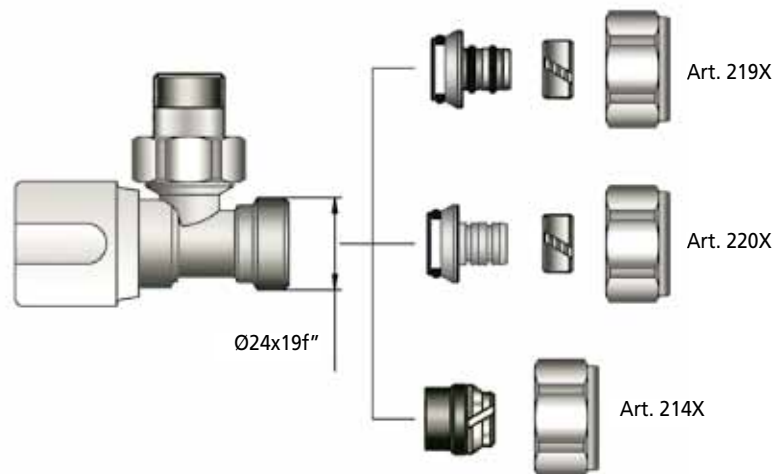
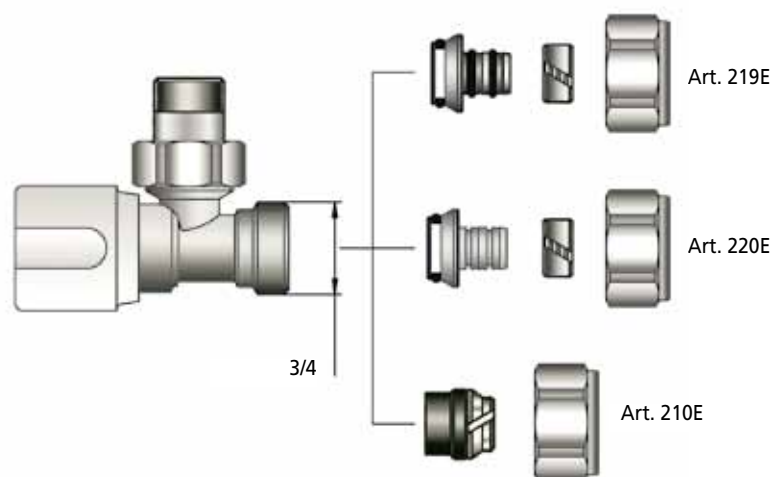
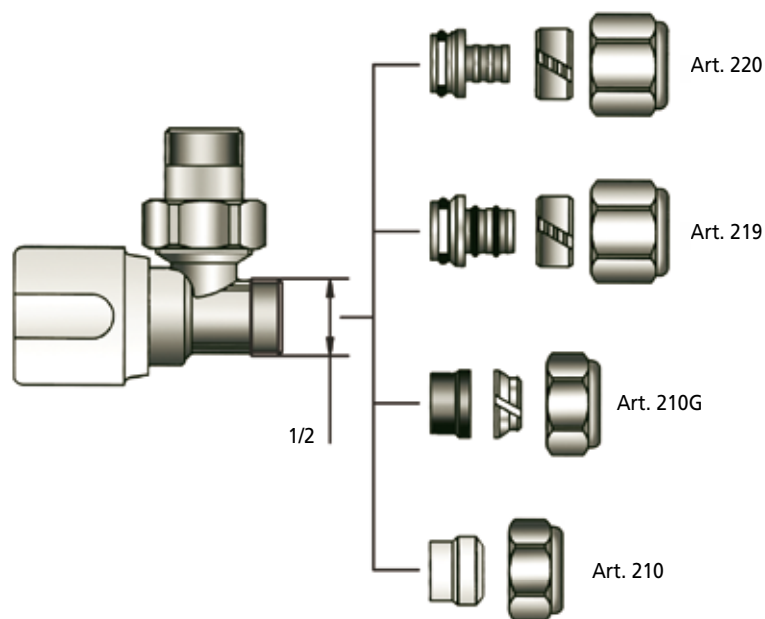



401-402-402B-402K-409-409K-410-410B-410K

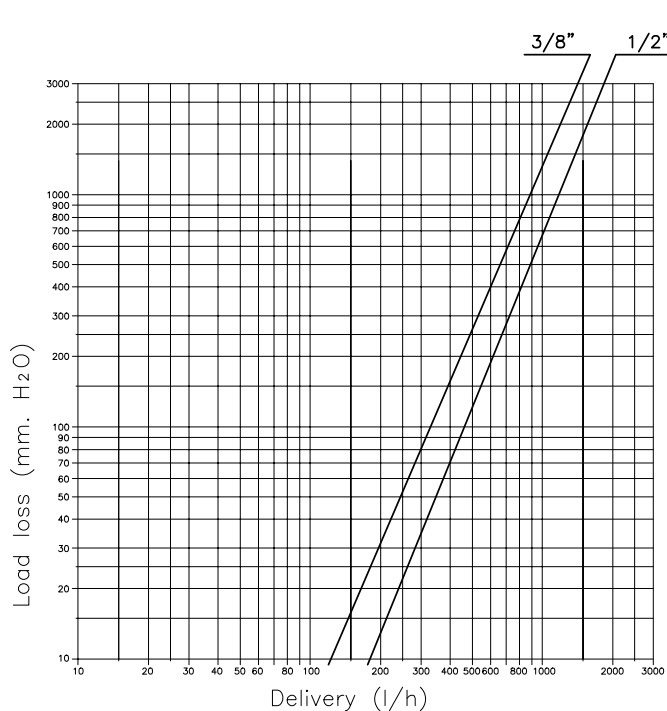

Kv 3/8" = 2,4 m³/h

Kv 1/2" = 3,0 m³/h

403-404-404B-404K-411-411K-412-412B-412K

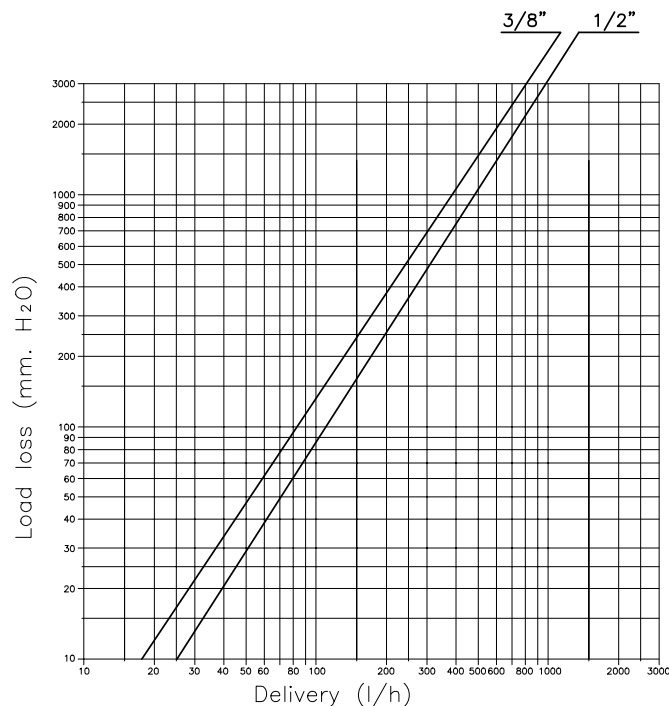

Kv 3/8" = 1,7 m³/h

Kv 1/2" = 2,1 m³/h

407-408-407S-408S-413-414-413E-414E

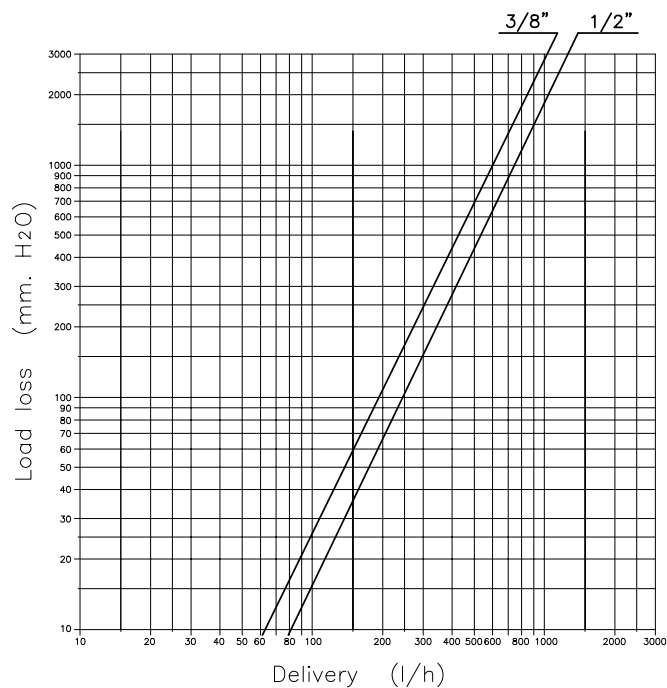

Kv 3/8" = 1,85 m³/h

Kv 1/2" = 2,2 m³/h

407D-408D-413D-414D

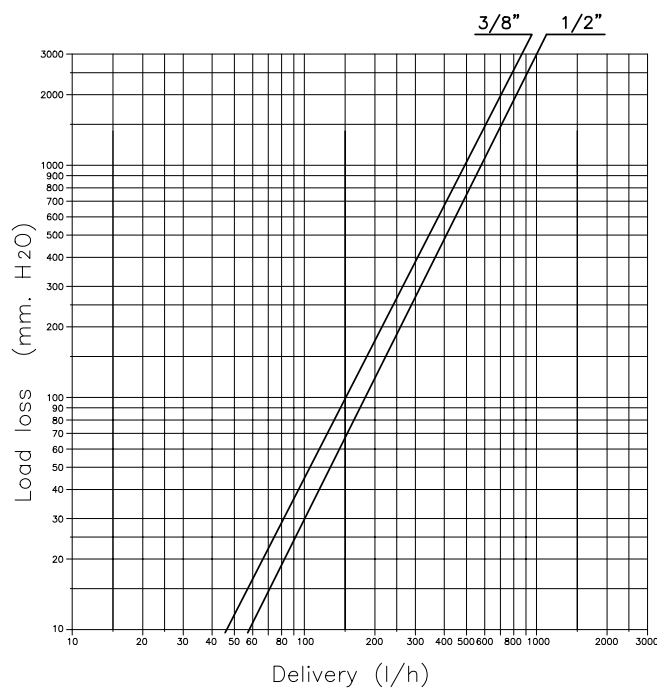

Kv 3/8" = 1,6 m³/h

Kv 1/2" = 1,8 m³/h



401T-409T-409TK

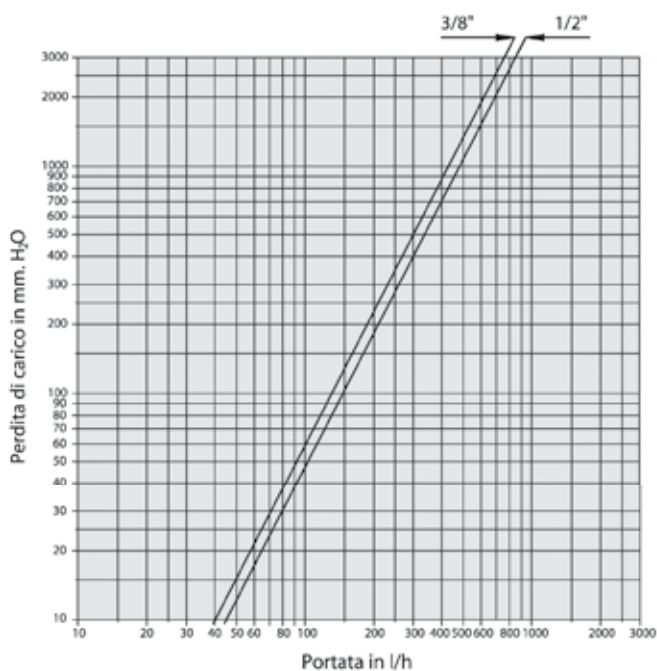

Kv 3/8" = 1,43 m³/h Kv 1/2" = 1,55 m³/h

403T-411T-411TK

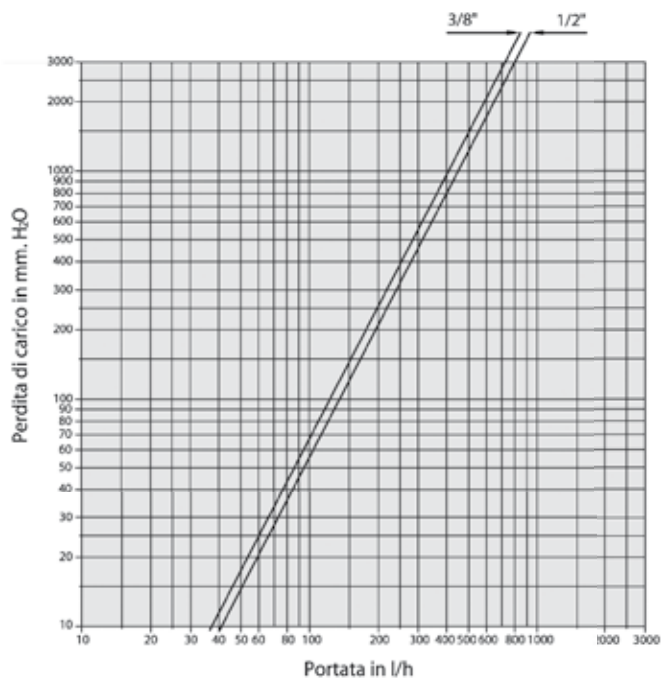

Kv 3/8" = 1,35 m³/h Kv 1/2" = 1,48 m³/h

385

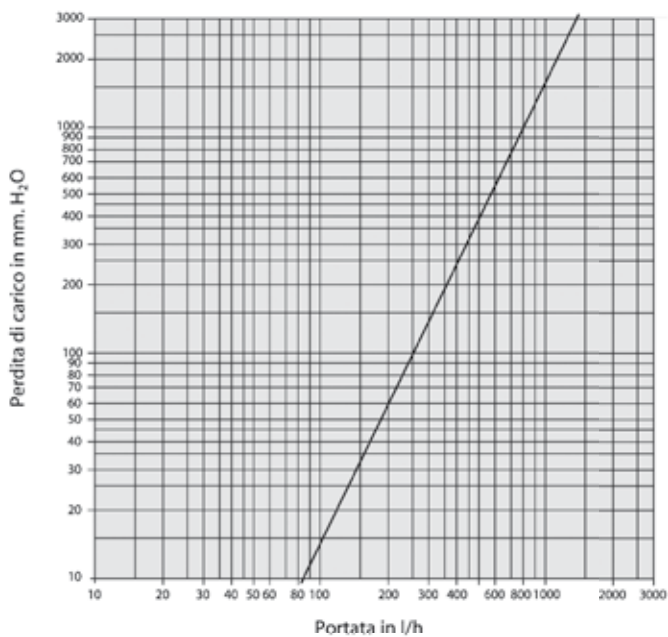

Valvola tutta aperta Kv = 2,5 m³/h

384 - 385T

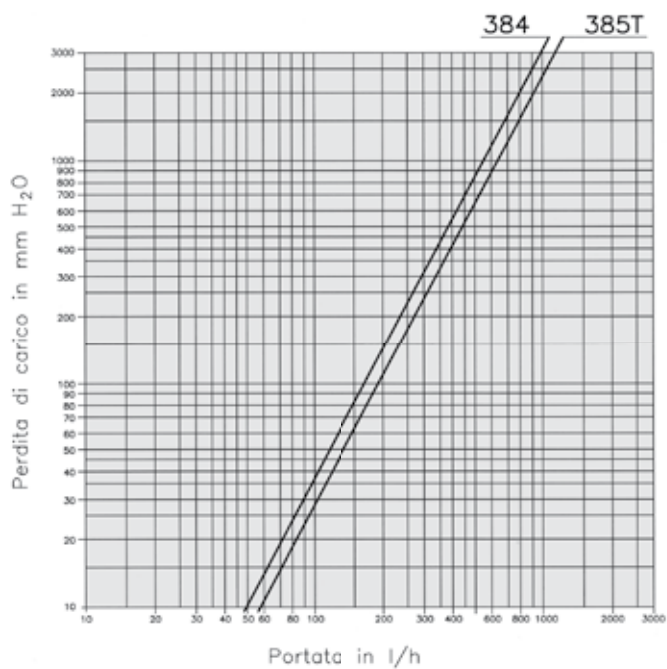

384 Kv = 1,8 m³/h

385T Kv = 2,1 m³/h



BIANCHI F.lli S.p.a.
Rubinetteria

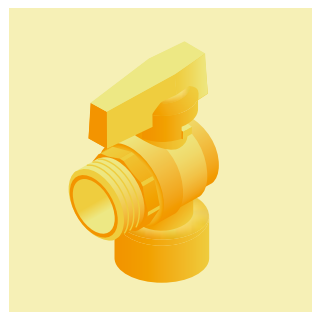
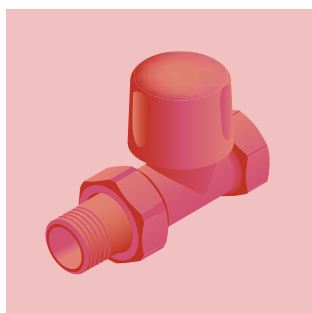
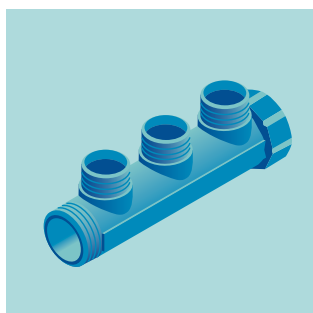

MADE IN ITALY
www.bianchifratelli.it