



Collettori lineari stampati
Linear forged manifolds
p. 14>16



Collettori premontati
in acciaio inox
*Pre-assembled stainless steel
manifolds*
p. 36>48



Collettori complanari
Double pattern manifolds
p. 16



Cassette e supporti
per collettori
*Boxes and mounting
brackets for manifolds*
p. 49>51



Collettori lineari estrusi
Linear extruded manifolds
p. 17>19



Tappi e raccordi per collettori
*Plugs and fittings for
manifolds*
p. 52>53



Collettori lineari
con rubinetto
*Linear extruded manifolds
with valve*
p. 20>23



Terminali per collettori
Terminal parts for manifolds
p. 54>55



Collettori premontati
in ottone
*Pre-assembled brass
manifolds*
p. 24>34



Accessori e ricambi
Accessories and spare parts
p. 56>57



Gruppo di miscelazione
a punto fisso
Fixed point regulation kit
p. 35





COLLETTORI

MANIFOLDS

Collettori lineari stampati | Linear forged manifolds

Temperatura massima d'esercizio / Max working temperature: 110°C

Pressione massima d'esercizio / Max working pressure: 10 bar

Corpo in ottone stampato / Body in forged brass

Filetti / Threads: ISO 228

Adatti per raccordi tubo rame, PEX, multistrato / Suitable for fittings for copper, PEX or multilayer piping

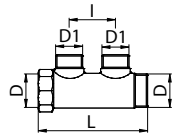

Collettore a 2 attacchi filetto maschio

Manifold with 2 male outlets

Colector de 2 empalmes rosca macho

202

Code	Version	Size (D)	Smooth	D1	H	I	L	€	Pack
2020050400		3/4"	●	1/2"	-	36	85	5,30	8
2020C50400		3/4"	●	1/2"	-	36	85	5,67	8
2020060400		1"	●	1/2"	-	36	85	6,95	8
Sede conica - Conical seat		diametro interno - inner diameter: 16mm							
2020050470		3/4"	●	1/2"	-	36	85	5,30	8
2020C50470		3/4"	●	1/2"	-	36	85	5,67	8
2020060470		1"	●	1/2"	-	36	85	6,95	8
2020C60470		1"	●	1/2"	-	36	85	7,36	8
Sede conica - Conical seat		diametro interno - inner diameter: 15mm							
2020050460		3/4"	●	1/2"	-	36	85	5,30	8
Sede piana - Flat seat		diametro interno - inner diameter: 15mm							

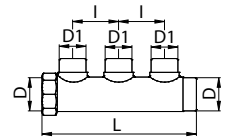

Collettore a 3 attacchi filetto maschio

Manifold with 3 male outlets

Colector de 3 empalmes rosca macho

203

Code	Version	Size (D)	Smooth	D1	H	I	L	€	Pack
2030050400		3/4"	●	1/2"	-	36	121	7,41	8
2030C50400		3/4"	●	1/2"	-	36	121	7,85	8
2030060400		1"	●	1/2"	-	36	121	9,83	6
Sede conica - Conical seat		diametro interno - inner diameter: 16mm							
2030050470		3/4"	●	1/2"	-	36	121	7,41	8
2030C50470		3/4"	●	1/2"	-	36	121	7,85	8
2030060470		1"	●	1/2"	-	36	121	9,83	6
2030C60470		1"	●	1/2"	-	36	121	10,29	6
Sede conica - Conical seat		diametro interno - inner diameter: 15mm							
2030050460		3/4"	●	1/2"	-	36	121	7,41	8
Sede piana - Flat seat		diametro interno - inner diameter: 15mm							

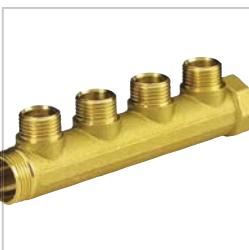
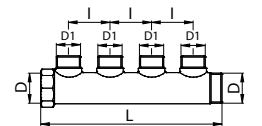

Collettore a 4 attacchi filetto maschio

Manifold with 4 male outlets

Colector de 4 empalmes rosca macho

204

Code	Version	Size (D)	Smooth	D1	H	I	L	€	Pack
2040050400		3/4"	●	1/2"	-	36	157	9,39	8
2040C50400		3/4"	●	1/2"	-	36	157	9,89	8
2040060400		1"	●	1/2"	-	36	157	12,80	6
Sede conica - Conical seat		diametro interno - inner diameter: 16mm							
2040050470		3/4"	●	1/2"	-	36	157	9,39	8
2040C50470		3/4"	●	1/2"	-	36	157	9,89	8
2040060470		1"	●	1/2"	-	36	157	12,80	6
2040C60470		1"	●	1/2"	-	36	157	13,31	6
Sede conica - Conical seat		diametro interno - inner diameter: 15mm							
2040050460		3/4"	●	1/2"	-	36	157	9,39	8
Sede piana - Flat seat		diametro interno - inner diameter: 15mm							

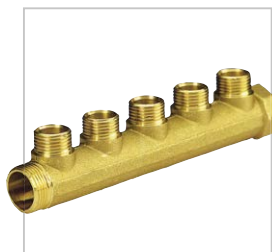

Collettore a 5 attacchi filetto maschio
Manifold with 5 male outlets
Colector de 5 empalmes rosca macho

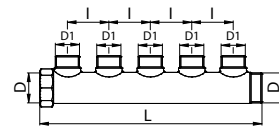

205

Code	Version	Size (D)	Smooth	D1	H	I	L	€	Pack
2050050400		3/4"	●	1/2"	-	36	193	13,31	8
2050C50400		3/4"	●	1/2"	-	36	193	13,94	8
2050060400		1"	●	1/2"	-	36	193	15,48	6
Sede conica - Conical seat		diametro interno - inner diameter: 16mm							
2050050470		3/4"	●	1/2"	-	36	193	13,31	8
Sede conica - Conical seat		diametro interno - inner diameter: 15mm							
2050050460		3/4"	●	1/2"	-	36	193	13,31	8
Sede piana - Flat seat		diametro interno - inner diameter: 15mm							



Collettore a 2 attacchi in ADZ filetto maschio Eurocono
DZR brass manifold with 2 male outlets Euroconus
Colector 2 empalmes Eurocono de ADZ

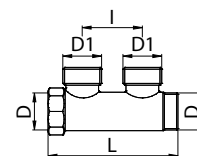

202E

Code	Version	Size (D)	Smooth	D1	H	I	L	€	Pack
202E05050A		3/4"	●	3/4"	-	50	108	7,66	8
202EC5050A		3/4"	●	3/4"	-	50	108	8,11	8
202E06050A		1"	●	3/4"	-	50	109	9,41	8

diametro interno / inner diameter: 18mm

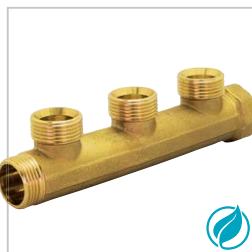

Collettore a 3 attacchi in ADZ filetto maschio Eurocono
DZR brass manifold with 3 male outlets Euroconus
Colector 3 empalmes Eurocono de ADZ

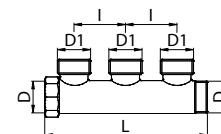

203E

Code	Version	Size (D)	Smooth	D1	H	I	L	€	Pack
203E05050A		3/4"	●	3/4"	-	50	158	11,58	8
203EC5050A		3/4"	●	3/4"	-	50	158	12,18	8
203E06050A		1"	●	3/4"	-	50	159	14,45	6

diametro interno / inner diameter: 18mm



Collettore a 2 attacchi filetto femmina
Manifold with 2 female outlets
Colector de 2 empalmes rosca hembra

222

Code	Version	Size (D)	Smooth	D1	H	I	L	€	Pack
2220050400		3/4"	●	1/2"	-	36	85	5,60	8
2220C50400		3/4"	●	1/2"	-	36	85	5,93	8
2220060400		1"	●	1/2"	-	36	85	7,29	8

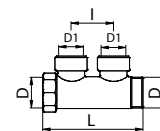

Collettore a 3 attacchi filetto femmina
Manifold with 3 female outlets
Colector de 3 empalmes rosca hembra

223

Code	Version	Size (D)	Smooth	D1	H	I	L	€	Pack
2230050400		3/4"	●	1/2"	-	36	121	8,31	8
2230C50400		3/4"	●	1/2"	-	36	121	8,81	8
2230060400		1"	●	1/2"	-	36	121	10,14	6

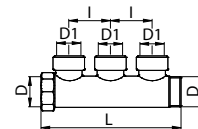

Collettore a 4 attacchi filetto femmina
Manifold with 4 female outlets
Colector de 4 empalmes rosca hembra

224

Code	Version	Size (D)	Smooth	D1	H	I	L	€	Pack
2240050400		3/4"	●	1/2"	-	36	157	11,23	8
2240C50400		3/4"	●	1/2"	-	36	157	11,86	8
2240060400		1"	●	1/2"	-	36	157	13,31	6

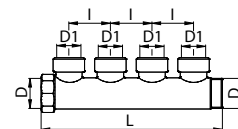
Collettori complanari | Double pattern manifolds

Temperatura massima d'esercizio / Max working temperature: 110°C
 Pressione massima d'esercizio / Max working pressure: 10 bar
 Corpo in ottone fuso / Body in casted brass
 Filetti / Threads: ISO 228
 Adatti per raccordi tubo rame, PEX, multistrato / Suitable for fittings for copper, PEX or multilayer piping
 Passaggio derivazione / Outlets inner diameter: 16 mm

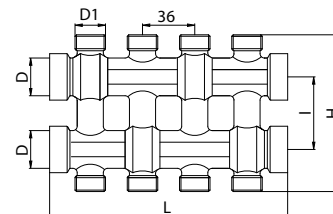

Collettore complanare componibile
Double pattern manifold
Colector coplanar modular

230

Code	Version	Size (D)	Smooth	D1	H	I	L	€	Pack
2304000500		3/4"	●	1/2"	108	50	164	31,60	2
4 vie - 4 ways - 4 vías									
2306000500		3/4"	●	1/2"	108	50	236	43,93	2
6 vie - 6 ways - 6 vías									
2308000500		3/4"	●	1/2"	108	50	308	60,78	2
8 vie - 8 ways - 8 vías									

Collettori lineari estrusi | Linear extruded manifolds

Temperatura massima d'esercizio / Max working temperature: 110°C

Pressione massima d'esercizio / Max working pressure: 10 bar

Corpo in ottone da barra profilata / Body in profiled brass bar

Filetti / Threads: ISO 228

Adatti per raccordi tubo rame, PEX, multistrato / Suitable for fittings for copper, PEX or multilayer piping

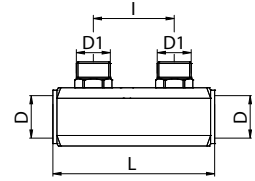

Collettore da barra
con attacchi maschio
3/4 Eurocono interasse
50mm, uscite maschio

*Manifold brass bar
with 3/4 male outlets,
type Euroconus,
interaxis 50mm*

*Colector de barra
con empalmes macho
3/4 Eurocono, distancia
entre ejes 50mm, salidas
macho*

242E÷250E

Code	Version	Size (D)	Smooth	D1	H	I	L	€	Pack
242E050500		3/4"	●	3/4"	-	50	102	11,68	6
242E060500		1"	●	3/4"	-	50	102	12,93	6
2 vie - 2 ways - 2 vías									
243E050500		3/4"	●	3/4"	-	50	152	16,85	4
243E060500		1"	●	3/4"	-	50	152	18,84	4
3 vie - 3 ways - 3 vías									
244E050500		3/4"	●	3/4"	-	50	202	22,36	4
244E060500		1"	●	3/4"	-	50	202	24,80	4
4 vie - 4 ways - 4 vías									
245E050500		3/4"	●	3/4"	-	50	252	28,51	3
245E060500		1"	●	3/4"	-	50	252	30,86	3
5 vie - 5 ways - 5 vías									
246E050500		3/4"	●	3/4"	-	50	302	32,97	4
246E060500		1"	●	3/4"	-	50	302	36,61	4
6 vie - 6 ways - 6 vía									
247E050500		3/4"	●	3/4"	-	50	352	38,81	2
247E060500		1"	●	3/4"	-	50	352	42,42	2
7 vie - 7 ways - 7 vías									
248E050500		3/4"	●	3/4"	-	50	402	43,86	2
248E060500		1"	●	3/4"	-	50	402	49,29	2
8 vie - 8 ways - 8 vías									
249E060500		1"	●	3/4"	-	50	452	54,97	1
9 vie - 9 ways - 9 vías									
250E060500		1"	●	3/4"	-	50	502	60,41	1
10 vie - 10 ways - 10 vías									



Collettore da barra
con attacchi femmina
1/2, interasse 50mm

Manifold made of brass
bar with 1/2 female
outlets, interaxis 50mm

Colector de barra
con empalmes hembra
1/2, distancia entre ejes
50mm

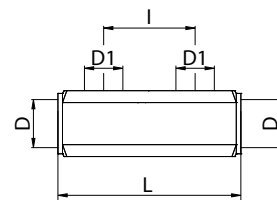
252÷262

Code	Version	Size (D)	Smooth	D1	H	I	L	€	Pack
2520050400		3/4"	●	1/2"	-	50	102	7,97	8
2520060400		1"	●	1/2"	-	50	102	9,25	8
2520070400		1 1/4"	●	1/2"	-	50	102	11,92	5
2 vie - 2 ways - 2 vías									
2530050400		3/4"	●	1/2"	-	50	152	11,65	6
2530060400		1"	●	1/2"	-	50	152	13,46	6
2530070400		1 1/4"	●	1/2"	-	50	152	17,77	4
3 vie - 3 ways - 3 vías									
2540050400		3/4"	●	1/2"	-	50	202	15,47	6
2540060400		1"	●	1/2"	-	50	202	17,66	6
2540070400		1 1/4"	●	1/2"	-	50	202	23,05	4
4 vie - 4 ways - 4 vías									
2550050400		3/4"	●	1/2"	-	50	252	20,09	6
2550060400		1"	●	1/2"	-	50	252	22,00	4
2550070400		1 1/4"	●	1/2"	-	50	252	28,70	2
5 vie - 5 ways - 5 vías									
2560050400		3/4"	●	1/2"	-	50	302	23,15	4
2560060400		1"	●	1/2"	-	50	302	26,16	4
2560070400		1 1/4"	●	1/2"	-	50	302	35,22	3
6 vie - 6 ways - 6 vías									
2570050400		3/4"	●	1/2"	-	50	352	27,33	4
2570060400		1"	●	1/2"	-	50	352	30,63	4
2570070400		1 1/4"	●	1/2"	-	50	352	40,71	2
7 vie - 7 ways - 7 vías									
2580050400		3/4"	●	1/2"	-	50	402	31,32	1
2580060400		1"	●	1/2"	-	50	402	34,72	1
2580070400		1 1/4"	●	1/2"	-	50	402	46,38	1
8 vie - 8 ways - 8 vías									
2590050400		3/4"	●	1/2"	-	50	452	34,49	1
2590060400		1"	●	1/2"	-	50	452	39,21	1
2590070400		1 1/4"	●	1/2"	-	50	452	52,15	1
9 vie - 9 ways - 9 vías									
2600050400		3/4"	●	1/2"	-	50	502	38,12	1
2600060400		1"	●	1/2"	-	50	502	43,37	1
2600070400		1 1/4"	●	1/2"	-	50	502	57,34	1
10 vie - 10 ways - 10 vías									



Collettore da barra
con attacchi femmina
1/2, interasse 50mm,
con foro di scarico 3/8"

*Manifold made of brass
bar with 1/2 female
outlets, interaxis 50mm,
with drain hole of 3/8"*

*Colector de barra con
empalmes hembra 1/2,
distancia entre ejes
50mm, con agujerificio
de drenaje 3/8"*

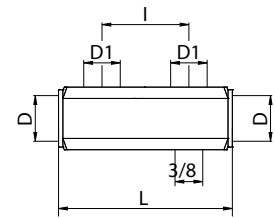
252A+262A

Code	Version	Size (D)	Smooth	D1	H	I	L	€	Pack
252A060400		1"	●	1/2"	-	50	102	9,57	8
2 vie - 2 ways - 2 vías									
253A060400		1"	●	1/2"	-	50	152	13,87	6
3 vie - 3 ways - 3 vías									
254A060400		1"	●	1/2"	-	50	202	18,08	6
4 vie - 4 ways - 4 vías									
255A060400		1"	●	1/2"	-	50	252	22,55	4
5 vie - 5 ways - 5 vías									
256A060400		1"	●	1/2"	-	50	302	26,99	4
6 vie - 6 ways - 6 vías									
257A060400		1"	●	1/2"	-	50	352	31,36	4
7 vie - 7 ways - 7 vías									
258A060400		1"	●	1/2"	-	50	402	35,55	1
8 vie - 8 ways - 8 vías									
259A060400		1"	●	1/2"	-	50	452	40,11	1
9 vie - 9 ways - 9 vías									
260A060400		1"	●	1/2"	-	50	502	44,36	1
10 vie - 10 ways - 10 vías									

Collettori lineari con rubinetto | Linear extruded manifolds with valve

Temperatura massima d'esercizio / Max working temperature: 100°C

Pressione massima d'esercizio / Max working pressure: 10 bar

Filetti / Threads: ISO 228

Adatti per raccordi tubo rame, PEX, multistrato / Suitable for fittings for copper, PEX or multilayer piping

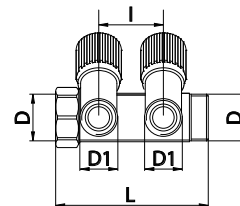

Collettore a 2 attacchi filetto maschio con valvola inclinata

Manifold with 2 male outlets and oblique valve
Colector de 2 empalmes rosca macho con válvula inclinada
202B

Code	Version	Size (D)	Smooth	D1	H	I	L	€	Pack
202B05040A		3/4"	●	1/2"	-	36	84	12,82	5
202B05040D		3/4"	●	1/2"	-	36	84	12,82	5
Sede conica - Conical seat		diametro interno - inner diameter: 16mm							
202B05047A		3/4"	●	1/2"	-	36	84	12,82	5
202B05047D		3/4"	●	1/2"	-	36	84	12,82	5
Sede conica - Conical seat		diametro interno - inner diameter: 15mm							
202B05046A		3/4"	●	1/2"	-	36	84	12,82	5
202B05046D		3/4"	●	1/2"	-	36	84	12,82	5
Sede piana - Flat seat		diametro interno - inner diameter: 15 mm							

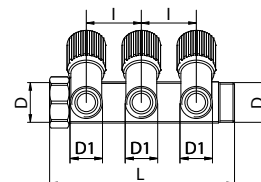

Collettore a 3 attacchi filetto maschio con valvola inclinata

Manifold with 3 male outlets and oblique valve
Colector de 3 empalmes rosca macho con válvula inclinada
203B

Code	Version	Size (D)	Smooth	D1	H	I	L	€	Pack
203B05040A		3/4"	●	1/2"	-	36	120	18,33	5
203B05040D		3/4"	●	1/2"	-	36	120	18,33	5
Sede conica - Conical seat		diametro interno - inner diameter: 16mm							
203B05047A		3/4"	●	1/2"	-	36	120	18,33	5
203B05047D		3/4"	●	1/2"	-	36	120	18,33	5
Sede conica - Conical seat		diametro interno - inner diameter: 15mm							
203B05046A		3/4"	●	1/2"	-	36	120	18,33	5
203B05046D		3/4"	●	1/2"	-	36	120	18,33	5
Sede piana - Flat seat		diametro interno - inner diameter: 15 mm							

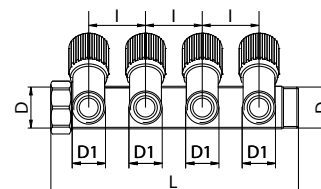

Collettore a 4 attacchi filetto maschio con valvola inclinata

Manifold with 4 male outlets and oblique valve
Colector de 4 empalmes rosca macho con válvula inclinada
204B

Code	Version	Size (D)	Smooth	D1	H	I	L	€	Pack
204B05040A		3/4"	●	1/2"	-	36	156	24,65	5
204B05040D		3/4"	●	1/2"	-	36	156	24,65	5
Sede conica - Conical seat		diametro interno - inner diameter: 16mm							
204B05047A		3/4"	●	1/2"	-	36	156	24,65	5
204B05047D		3/4"	●	1/2"	-	36	156	24,65	5
Sede conica - Conical seat		diametro interno - inner diameter: 15mm							
204B05046A		3/4"	●	1/2"	-	36	156	24,65	5
204B05046D		3/4"	●	1/2"	-	36	156	24,65	5
Sede piana - Flat seat		diametro interno - inner diameter: 15 mm							



Collettore a 2 attacchi in ADZ, attacco Eurocono

DZR brass Euroconus manifold with 2 male outlets

Colector ADZ de 2 empalmes Eurocono

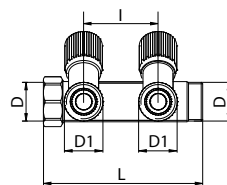

202F

Code	Version	Size (D)	Smooth	D1	H	I	L	€	Pack
202F0505AA		3/4"	●	3/4"	-	50	107	16,40	5
202F0505AD		3/4"	●	3/4"	-	50	107	16,40	5

Sede conica - Conical seat diametro interno - inner diameter: 18mm

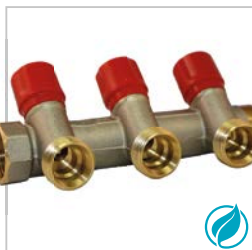

Collettore a 3 attacchi in ADZ, attacco Eurocono

DZR brass Euroconus manifold with 3 male outlets

Colector ADZ de 3 empalmes Eurocono

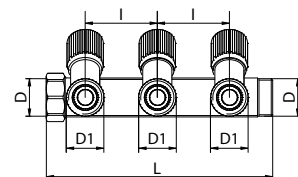

203F

Code	Version	Size (D)	Smooth	D1	H	I	L	€	Pack
203F0505AA		3/4"	●	3/4"	-	50	157	24,27	5
203F0505AD		3/4"	●	3/4"	-	50	157	24,27	5

Sede conica - Conical seat diametro interno - inner diameter: 18mm

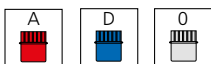

Collettore 2 attacchi filetto maschio con valvola inclinata

Manifold with 2 male outlets and oblique valve

Colector 2 empalmes rosca macho con valvula inclinada

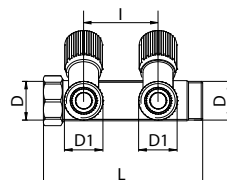

202FX

Code	Version	Size (D)	Smooth	D1	H	I	L	€	Pack
202FX6000A		1"	●	24x19	-	42	92	15,32	5
202FX6000D		1"	●	24x19	-	42	92	15,32	5
202FX60000		1"	●	24x19	-	42	92	15,32	5

Sede conica - Conical seat diametro interno - inner diameter: 18mm

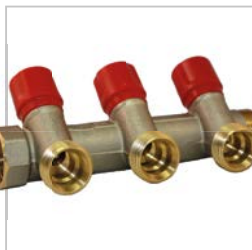
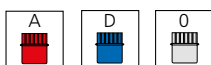

Collettore 3 attacchi filetto maschio con valvola inclinata

Manifold with 3 male outlets and oblique valve

Colector 3 empalmes rosca macho con valvula inclinada

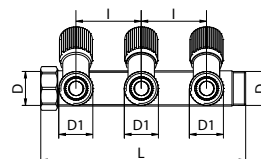

203FX

Code	Version	Size (D)	Smooth	D1	H	I	L	€	Pack
203FX6000A		1"	●	24x19	-	42	132	22,78	5
203FX6000D		1"	●	24x19	-	42	132	22,78	5
203FX60000		1"	●	24x19	-	42	132	22,78	5

Sede conica - Conical seat diametro interno - inner diameter: 18mm

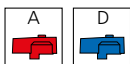

Collettore a 2 attacchi filetto maschio Eurocono con valvola a sfera incorporata

2 ways male manifold Euroconus with incorporated ball valve

Colector de 2 empalmes rosca macho Eurocono con válvulas de bola incorporada

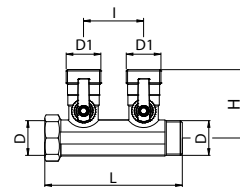
202C

Code	Version	Size (D)	Smooth	D1	H	I	L	€	Pack
202C05050A		3/4"	●	3/4"	55	45	103	15,48	5
202C05050D		3/4"	●	3/4"	55	45	103	15,48	5
202C06050A		1"	●	3/4"	55	45	103	17,20	5
202C06050D		1"	●	3/4"	55	45	103	17,20	5

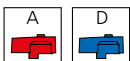

Collettore a 3 attacchi filetto maschio Eurocono con valvola a sfera incorporata

3 ways male manifold Euroconus with incorporated ball valve

Colector de 3 empalmes rosca macho Eurocono con válvulas de bola incorporada

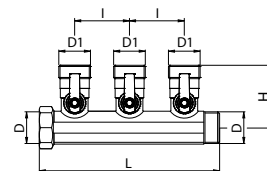
203C

Code	Version	Size (D)	Smooth	D1	H	I	L	€	Pack
203C05050A		3/4"	●	3/4"	55	45	148	21,21	5
203C05050D		3/4"	●	3/4"	55	45	148	21,21	5
203C06050A		1"	●	3/4"	55	45	148	24,21	5
203C06050D		1"	●	3/4"	55	45	148	24,21	5

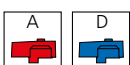

Collettore a 4 attacchi filetto maschio Eurocono con valvola a sfera incorporata

4 ways male manifold Euroconus with incorporated ball valve

Colector de 4 empalmes rosca macho Eurocono con válvulas de bola incorporada

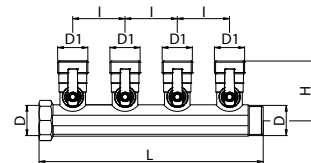
204C

Code	Version	Size (D)	Smooth	D1	H	I	L	€	Pack
204C05050A		3/4"	●	3/4"	55	45	193	28,41	4
204C05050D		3/4"	●	3/4"	55	45	193	28,41	4
204C06050A		1"	●	3/4"	55	45	193	30,20	4
204C06050D		1"	●	3/4"	55	45	193	30,20	4

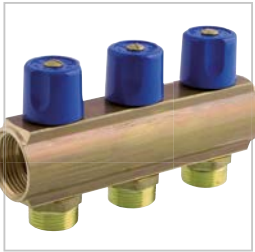
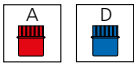

Collettore da barra con attacchi maschio 3/4 Eurocono, valvole incorporate

Manifold made of brass bar with 3/4 Euroconus male outlets and incorporated valves

Colector de barra con empalmes macho Eurocono 3/4, válvulas incorporadas

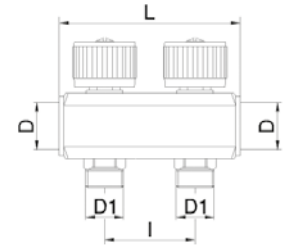

232E÷240E

Code	Version	Size (D)	Smooth	D1	H	I	L	€	Pack
232E06050A		1"	●	3/4"	-	50	102	18,94	4
232E06050D		1"	●	3/4"	-	50	102	18,94	4
2 vie - 2 ways - 2 vías									
233E06050A		1"	●	3/4"	-	50	152	27,85	4
233E06050D		1"	●	3/4"	-	50	152	27,85	4
3 vie - 3 ways - 3 vías									
234E06050A		1"	●	3/4"	-	50	202	36,44	4
234E06050D		1"	●	3/4"	-	50	202	36,44	4
4 vie - 4 ways - 4 vías									
235E06050A		1"	●	3/4"	-	50	252	45,68	2
235E06050D		1"	●	3/4"	-	50	252	45,68	2
5 vie - 5 ways - 5 vías									
236E06050A		1"	●	3/4"	-	50	302	54,14	2
236E06050D		1"	●	3/4"	-	50	302	54,14	2
6 vie - 6 ways - 6 vías									
237E06050A		1"	●	3/4"	-	50	352	61,85	2
237E06050D		1"	●	3/4"	-	50	352	61,85	2
7 vie - 7 ways - 7 vías									
238E06050A		1"	●	3/4"	-	50	402	70,04	2
238E06050D		1"	●	3/4"	-	50	402	70,04	2
8 vie - 8 ways - 8 vías									
239E06050A		1"	●	3/4"	-	50	452	78,36	2
239E06050D		1"	●	3/4"	-	50	452	78,36	2
9 vie - 9 ways - 9 vías									
240E06050A		1"	●	3/4"	-	50	502	87,52	2
240E06050D		1"	●	3/4"	-	50	502	87,52	2
10 vie - 10 ways - 10 vías									

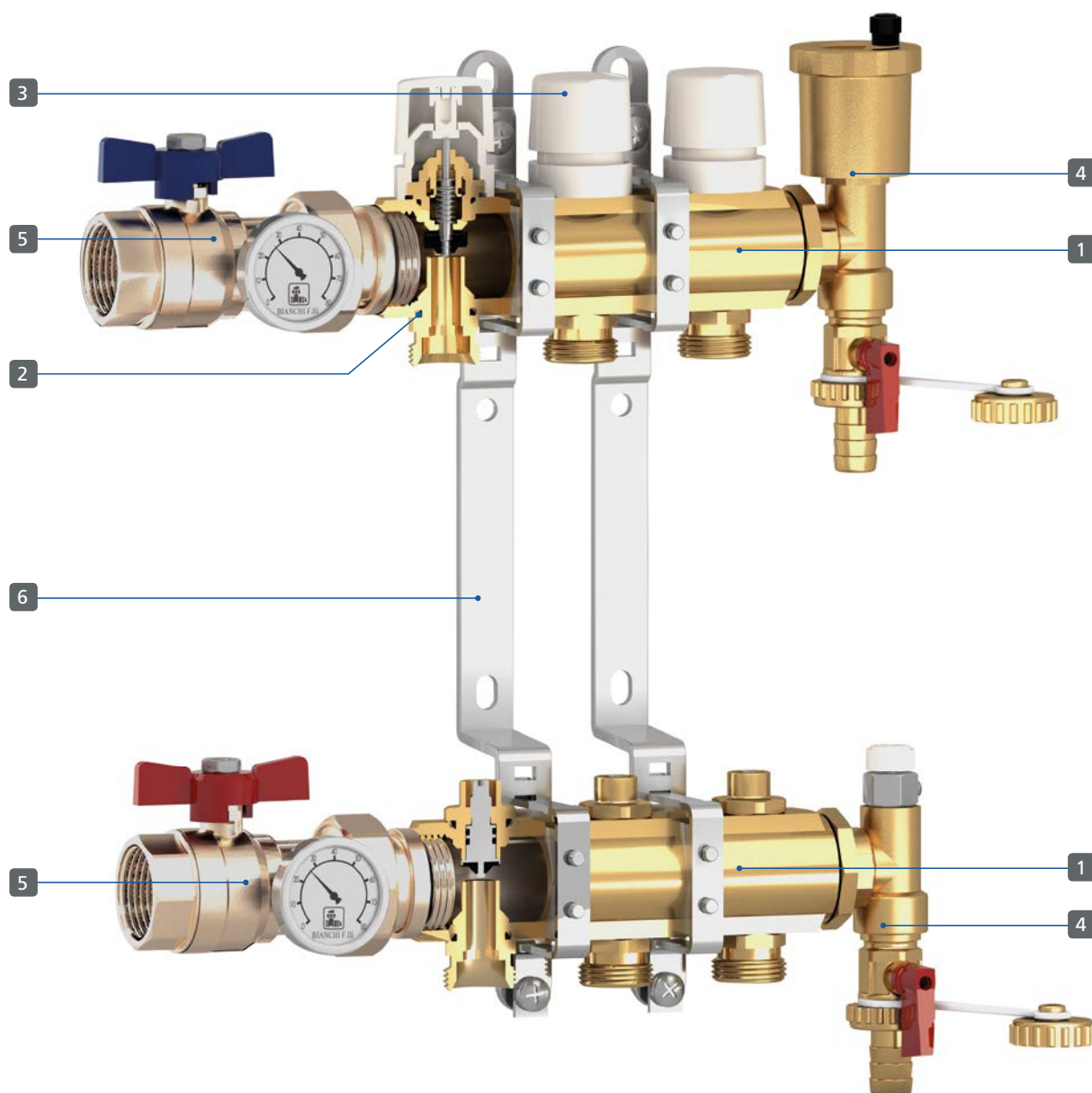
Collettori premontati in ottone | Pre-assembled brass manifolds

Scheda materiali | Materials

Denominazione	Pz.	Materiale
1 Collettore / Manifold	2	OTTONE / BRASS CW614N
2 O-ring / O-ring	-	EPDM / VITON
3 Volantino / Handle wheels	-	ABS
4 Terminale / Terminal part	2	OTTONE / BRASS CW617N
5 Valvola a sfera / Ball valve	2	OTTONE / BRASS CW617N
6 Staffa di fissaggio / Mounting Bracket	2	ACCIAIO / STEEL

• Caratteristiche generali / General informations

Temperatura d'esercizio / Working temperature: 5-80°C

Pressione massima d'esercizio / Max working pressure: 10 bar

Filetti / Threads: ISO 228

Adatti per raccordi tubo rame, PEX, multistrato / Suitable for fittings for copper, PEX or multilayer piping

Fluidi ammessi: Acqua (percentuale massima di glicole: 50%) / Allowed fluids: water (Glycole max percentage: 50%)

Abbinabili agli attuatori / Available with actuators: art.350-351

Le valvole a sfera devono essere utilizzate in posizione totalmente aperta-chiusa / Ball valves must be used in totally open-close position

I collettori vengono forniti già montati sulle staffe di supporto; gli accessori saranno forniti smontati all'interno della stessa scatola / Manifolds will be supplied mounted on the brackets; accessories will be supplied separately, inside the same box.

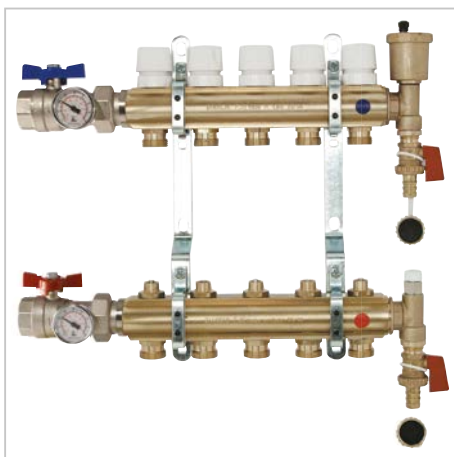

Collettori da barra FF con attacchi 3/4" M eurocono con vitone termostatico e detentori.
Valvole a sfera con termometro Art. 422M.
Staffe di supporto Art. 271 e terminali per collettori Art. 298 e 299

FF brass bar manifolds with 3/4" male Euroconus outlets, with thermostatic screw and lockshield valves. Ball valves with thermometer included Art. 422M. Manifold's brackets Art. 271 and terminal parts for manifolds Art. 298 and 299

Colectores HH con empalmes 3/4" M eurocono con valvulas de regulacion termostaticables y detentores. Valvula de bola con termometro incorporado Art. 422M. Soportes Art. 271 y tapones terminales Art. 298 y 299

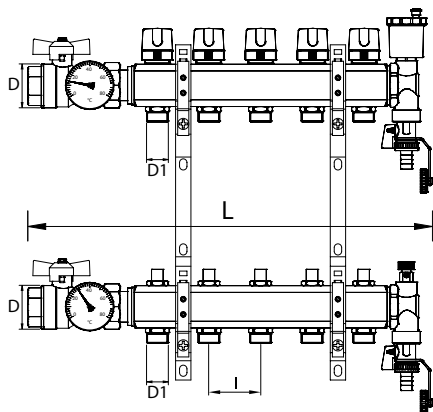
C332A÷C3402A

Code	Version	Size (D)	Smooth	D1	H	I	L	€	Pack
C332A60500		1"	●	3/4"	-	50	250	143,08	1
C332A70500		1 1/4"	●	3/4"	-	50	296	182,03	1
2 vie - 2 ways - 2 vías									
C333A60500		1"	●	3/4"	-	50	300	172,94	1
C333A70500		1 1/4"	●	3/4"	-	50	346	210,02	1
3 vie - 3 ways - 3 vías									
C334A60500		1"	●	3/4"	-	50	350	197,16	1
C334A70500		1 1/4"	●	3/4"	-	50	396	240,54	1
4 vie - 4 ways - 4 vías									
C335A60500		1"	●	3/4"	-	50	400	220,69	1
C335A70500		1 1/4"	●	3/4"	-	50	446	253,91	1
5 vie - 5 ways - 5 vías									
C336A60500		1"	●	3/4"	-	50	450	240,64	1
C336A70500		1 1/4"	●	3/4"	-	50	496	289,45	1
6 vie - 6 ways - 6 vías									
C337A60500		1"	●	3/4"	-	50	500	265,48	1
C337A70500		1 1/4"	●	3/4"	-	50	546	315,11	1
7 vie - 7 ways - 7 vías									
C338A60500		1"	●	3/4"	-	50	550	288,11	1
C338A70500		1 1/4"	●	3/4"	-	50	596	342,77	1
8 vie - 8 ways - 8 vías									
C339A60500		1"	●	3/4"	-	50	600	310,53	1
C339A70500		1 1/4"	●	3/4"	-	50	646	374,30	1
9 vie - 9 ways - 9 vías									
C340A60500		1"	●	3/4"	-	50	650	332,49	1
C340A70500		1 1/4"	●	3/4"	-	50	696	394,73	1
10 vie - 10 ways - 10 vías									
C340A60501		1"	●	3/4"	-	50	700	359,26	1
C340A70501		1 1/4"	●	3/4"	-	50	746	422,17	1
11 vie - 11 ways - 11 vías									
C340A60502		1"	●	3/4"	-	50	750	385,19	1
C340A70502		1 1/4"	●	3/4"	-	50	796	450,03	1
12 vie - 12 ways - 12 vías									

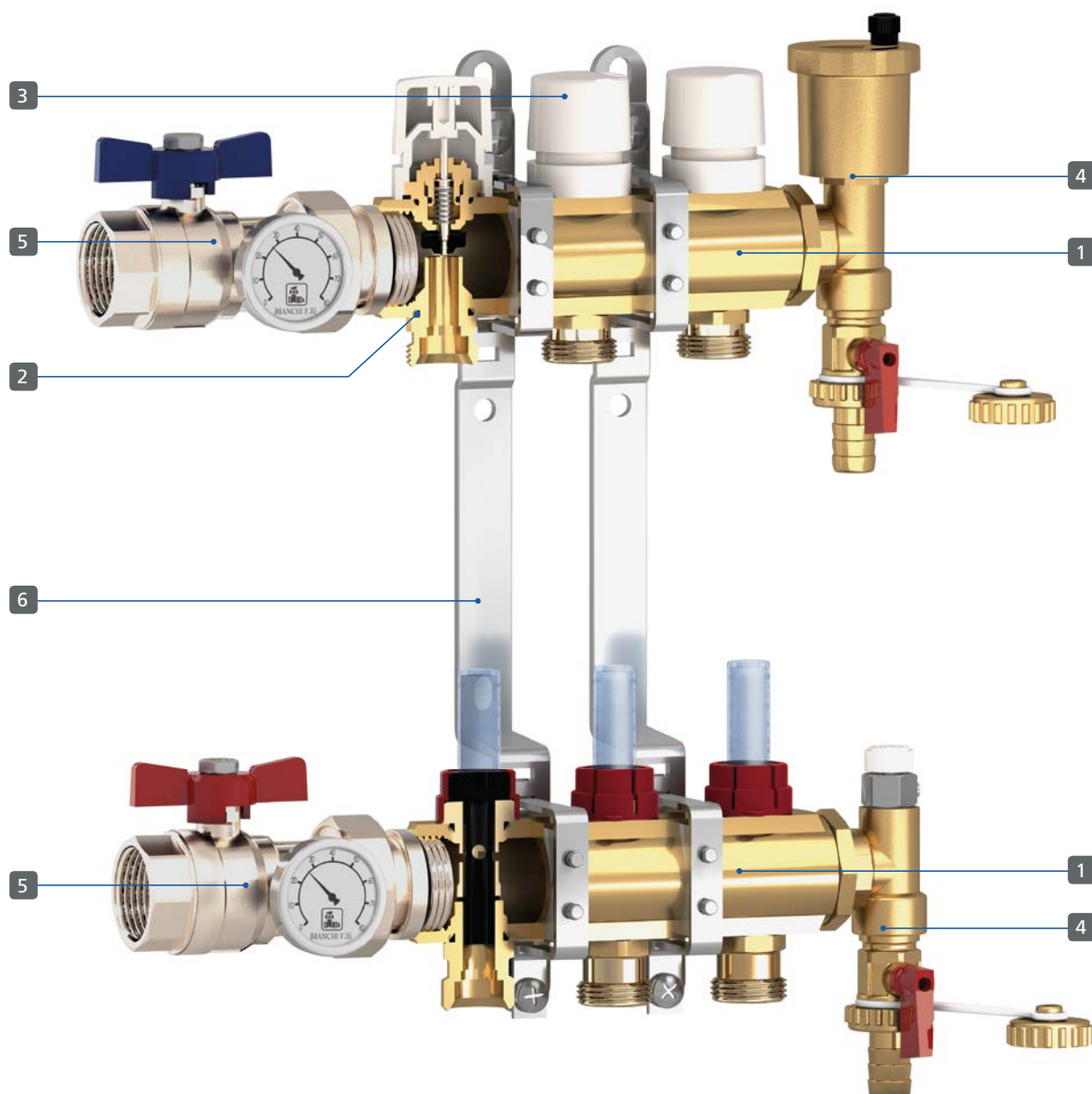
Scheda materiali | Materials

Denominazione	Pz.	Materiale
1 Collettore / Manifold	2	OTTONE / BRASS UNI EN 12168 CW614N
2 O-ring / O-ring	-	EPDM / VITON
3 Volantino / Handle wheels	-	ABS
4 Terminale / Terminal part	2	OTTONE / BRASS CW617N
5 Valvola a sfera / Ball valve	2	OTTONE / BRASS CW617N
6 Staffa di fissaggio / Mounting Bracket	2	ACCIAIO / STEEL

• Caratteristiche generali / General informations

Temperatura d'esercizio / Working temperature: 5-70°C

Pressione massima d'esercizio / Max working pressure: 6 bar

Filetti / Threads: ISO 228

Scala Flussimetro / Flowmeter scale: 0-8 l/min

Adatti per raccordi tubo rame, PEX, multistrato / Suitable for fittings for copper, PEX or multilayer piping

Fluidi ammessi: Acqua (percentuale massima di glicole: 50%) / Allowed fluids: water (Glycole max percentage: 50%)

Abbinabili agli attuatori / Available with actuators: art.350-351

Le valvole a sfera devono essere utilizzate in posizione totalmente aperta-chiusa / Ball valves must be used in totally open-close position

I collettori vengono forniti già montati sulle staffe di supporto; gli accessori saranno forniti smontati all'interno della stessa scatola / Manifolds will be supplied mounted on the brackets; accessories will be supplied separately, inside the same box

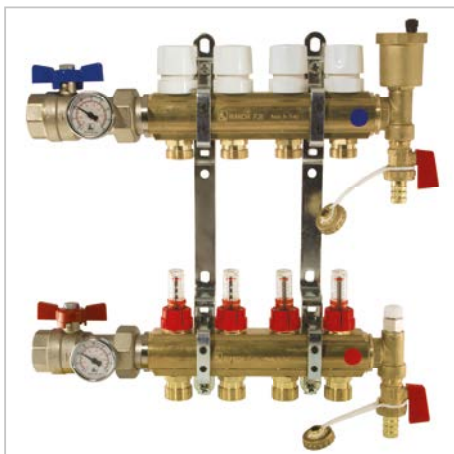

Collettori da barra FF con attacchi 3/4" M eurocono con vitone termostatico e regolatori di flusso a scala graduata.

Valvole a sfera con termometro Art. 422M.

Staffe di supporto Art. 271 e terminali per collettori Art. 298 e 299

FF brass bar manifolds with 3/4" male Euroconus outlets, with thermostatic screw and flow meters. Ball valves with thermometer included Art. 422M. Manifold's brackets Art. 271 and terminal parts for manifolds Art. 298 and 299

Colectores de barra HH con empalmes 3/4" M eurocono con valvulas de regulación termostaticables y caudalímetros. Válvula de bola con termómetro incorporado Art. 422M. Soportes Art. 271 y tapones terminales Art. 298 y 299

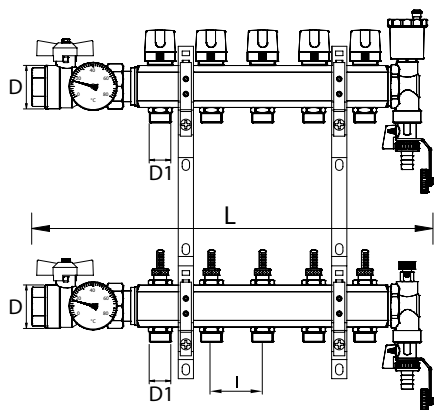

C342A÷C3502A

Code	Version	Size (D)	Smooth	D1	H	I	L	€	Pack
C342A60500		1"	●	3/4"	-	50	250	159,44	1
C342A70500		1 1/4"	●	3/4"	-	50	296	195,66	1
2 vie - 2 ways - 2 vías									
C343A60500		1"	●	3/4"	-	50	300	191,34	1
C343A70500		1 1/4"	●	3/4"	-	50	346	233,14	1
3 vie - 3 ways - 3 vías									
C344A60500		1"	●	3/4"	-	50	350	219,19	1
C344A70500		1 1/4"	●	3/4"	-	50	396	264,02	1
4 vie - 4 ways - 4 vías									
C345A60500		1"	●	3/4"	-	50	400	253,30	1
C345A70500		1 1/4"	●	3/4"	-	50	446	303,49	1
5 vie - 5 ways - 5 vías									
C346A60500		1"	●	3/4"	-	50	450	286,70	1
C346A70500		1 1/4"	●	3/4"	-	50	496	335,59	1
6 vie - 6 ways - 6 vía									
C347A60500		1"	●	3/4"	-	50	500	312,95	1
C347A70500		1 1/4"	●	3/4"	-	50	546	370,40	1
7 vie - 7 ways - 7 vías									
C348A60500		1"	●	3/4"	-	50	550	342,47	1
C348A70500		1 1/4"	●	3/4"	-	50	596	402,77	1
8 vie - 8 ways - 8 vías									
C349A60500		1"	●	3/4"	-	50	600	370,49	1
C349A70500		1 1/4"	●	3/4"	-	50	646	442,96	1
9 vie - 9 ways - 9 vías									
C350A60500		1"	●	3/4"	-	50	650	400,69	1
C350A70500		1 1/4"	●	3/4"	-	50	696	482,69	1
10 vie - 10 ways - 10 vías									
C350A60501		1"	●	3/4"	-	50	700	438,43	1
C350A70501		1 1/4"	●	3/4"	-	50	746	518,50	1
11 vie - 11 ways - 11 vías									
C350A60502		1"	●	3/4"	-	50	750	472,92	1
C350A70502		1 1/4"	●	3/4"	-	50	796	556,59	1
12 vie - 12 ways - 12 vías									

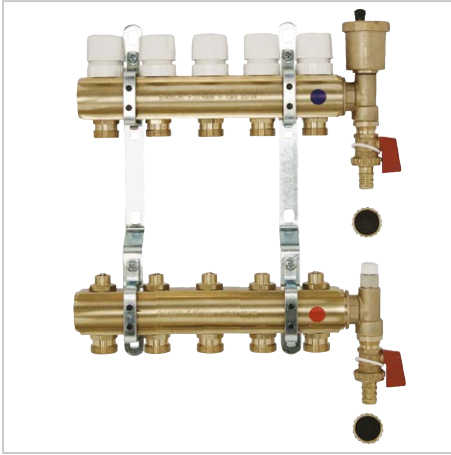

Collettori da barra FF con attacchi 3/4" M eurocono con vitone termostatico e detentori. Staffe di supporto Art. 271 e terminali per collettori Art. 298 e 299

FF brass bar manifolds with 3/4" male Euroconus outlets, with thermostatic screw and lockshield valves. Manifold's brackets Art. 271 and terminal parts for manifolds Art. 298 and 299

Colectores HH con empalmes 3/4" M eurocono con valvulas de regulacion termostaticas y detentores. Soportes Art. 271 y tapones terminales Art. 298 y 299

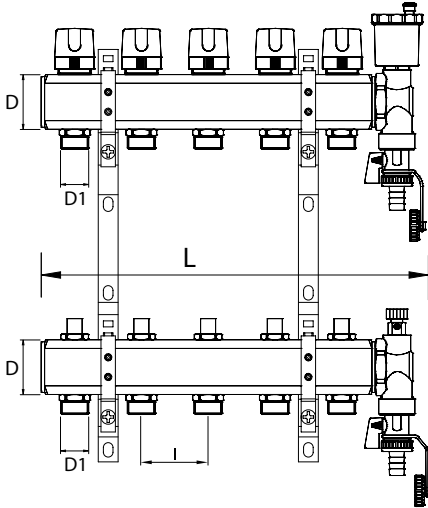
C332÷C3402

Code	Version	Size (D)	Smooth	D1	H	I	L	€	Pack
C332060500		1"	●	3/4"	-	50	154	91,16	1
C332070500		1 1/4"	●	3/4"	-	50	154	115,57	1
2 vie - 2 ways - 2 vías									
C333060500		1"	●	3/4"	-	50	204	117,97	1
C333070500		1 1/4"	●	3/4"	-	50	204	147,85	1
3 vie - 3 ways - 3 vías									
C334060500		1"	●	3/4"	-	50	254	140,55	1
C334070500		1 1/4"	●	3/4"	-	50	254	172,84	1
4 vie - 4 ways - 4 vías									
C335060500		1"	●	3/4"	-	50	304	162,43	1
C335070500		1 1/4"	●	3/4"	-	50	304	196,05	1
5 vie - 5 ways - 5 vías									
C336060500		1"	●	3/4"	-	50	354	183,25	1
C336070500		1 1/4"	●	3/4"	-	50	354	223,80	1
6 vie - 6 ways - 6 vía									
C337060500		1"	●	3/4"	-	50	404	204,86	1
C337070500		1 1/4"	●	3/4"	-	50	404	248,84	1
7 vie - 7 ways - 7 vías									
C338060500		1"	●	3/4"	-	50	454	226,36	1
C338070500		1 1/4"	●	3/4"	-	50	454	278,88	1
8 vie - 8 ways - 8 vías									
C339060500		1"	●	3/4"	-	50	504	248,50	1
C339070500		1 1/4"	●	3/4"	-	50	504	312,11	1
9 vie - 9 ways - 9 vías									
C340060500		1"	●	3/4"	-	50	554	270,24	1
C340070500		1 1/4"	●	3/4"	-	50	554	342,63	1
10 vie - 10 ways - 10 vías									
C340160500		1"	●	3/4"	-	50	604	293,55	1
C340170500		1 1/4"	●	3/4"	-	50	604	368,99	1
11 vie - 11 ways - 11 vías									
C340260500		1"	●	3/4"	-	50	654	314,18	1
C340270500		1 1/4"	●	3/4"	-	50	654	396,83	1
12 vie - 12 ways - 12 vías									



Collettori da barra FF con attacchi 3/4" M eurocono con vitone termostatico e regolatori di flusso. Staffe di supporto Art. 271 e terminali per collettori Art. 298 e 299

FF brass bar manifolds with 3/4" male Euroconus outlets, with thermostatic screw and flow meters. Manifold's brackets Art. 271 and terminal parts for manifolds Art. 298 and 299

Colectores HH con empalmes 3/4" M eurocono con valvulas de regulacion termostaticas y caudalímetros. Soportes Art. 271 y tapones terminales Art. 298 y 299

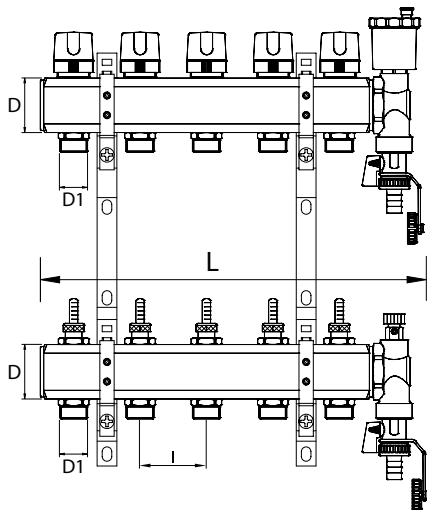
C342÷C3502

Code	Version	Size (D)	Smooth	D1	H	I	L	€	Pack
C342060500		1"	●	3/4"	-	50	154	102,30	1
C342070500		1 1/4"	●	3/4"	-	50	154	126,86	1
2 vie - 2 ways - 2 vías									
C343060500		1"	●	3/4"	-	50	204	138,66	1
C343070500		1 1/4"	●	3/4"	-	50	204	162,59	1
3 vie - 3 ways - 3 vías									
C344060500		1"	●	3/4"	-	50	254	165,43	1
C344070500		1 1/4"	●	3/4"	-	50	254	194,96	1
4 vie - 4 ways - 4 vías									
C345060500		1"	●	3/4"	-	50	304	198,65	1
C345070500		1 1/4"	●	3/4"	-	50	304	228,04	1
5 vie - 5 ways - 5 vías									
C346060500		1"	●	3/4"	-	50	354	227,05	1
C346070500		1 1/4"	●	3/4"	-	50	354	256,26	1
6 vie - 6 ways - 6 vías									
C347060500		1"	●	3/4"	-	50	404	257,69	1
C347070500		1 1/4"	●	3/4"	-	50	404	289,66	1
7 vie - 7 ways - 7 vías									
C348060500		1"	●	3/4"	-	50	454	287,81	1
C348070500		1 1/4"	●	3/4"	-	50	454	323,56	1
8 vie - 8 ways - 8 vías									
C349060500		1"	●	3/4"	-	50	504	316,84	1
C349070500		1 1/4"	●	3/4"	-	50	504	363,77	1
9 vie - 9 ways - 9 vías									
C350060500		1"	●	3/4"	-	50	554	348,54	1
C350070500		1 1/4"	●	3/4"	-	50	554	403,19	1
10 vie - 10 ways - 10 vías									
C350160500		1"	●	3/4"	-	50	604	402,70	1
C350170500		1 1/4"	●	3/4"	-	50	604	439,03	1
11 vie - 11 ways - 11 vías									
C350260500		1"	●	3/4"	-	50	654	416,51	1
C350270500		1 1/4"	●	3/4"	-	50	654	473,14	1
12 vie - 12 ways - 12 vías									



Collettori da barra FF con attacchi 3/4" M eurocono con vitone termostatico e detentori. Staffe di supporto Art. 271

FF brass bar manifolds with 3/4" male Euroconus outlets, with thermostatic screw and lockshield valves. Manifold's brackets Art. 271

Colectores HH con empalmes 3/4" M eurocono con valvulas de regulacion termostaticas y detentores. Soportes Art. 271

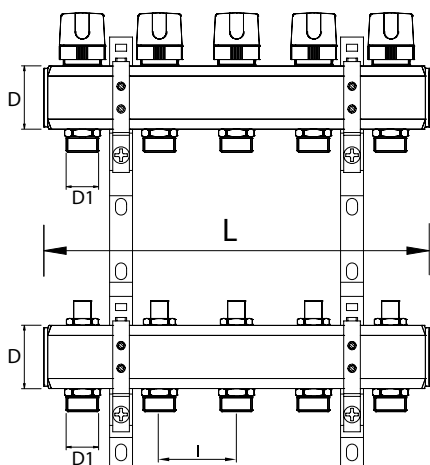
C312÷C3202

Code	Version	Size (D)	Smooth	D1	H	I	L	€	Pack
C312060500		1"	●	3/4"	-	50	102	54,91	1
C312070500		1 1/4"	●	3/4"	-	50	102	65,98	1
2 vie - 2 ways - 2 vías									
C313060500		1"	●	3/4"	-	50	152	80,41	1
C313070500		1 1/4"	●	3/4"	-	50	152	97,69	1
3 vie - 3 ways - 3 vías									
C314060500		1"	●	3/4"	-	50	202	101,74	1
C314070500		1 1/4"	●	3/4"	-	50	202	121,79	1
4 vie - 4 ways - 4 vías									
C315060500		1"	●	3/4"	-	50	252	123,51	1
C315070500		1 1/4"	●	3/4"	-	50	252	150,52	1
5 vie - 5 ways - 5 vías									
C316060500		1"	●	3/4"	-	50	302	144,98	1
C316070500		1 1/4"	●	3/4"	-	50	302	175,01	1
6 vie - 6 ways - 6 vía									
C317060500		1"	●	3/4"	-	50	352	167,90	1
C317070500		1 1/4"	●	3/4"	-	50	352	206,56	1
7 vie - 7 ways - 7 vías									
C318060500		1"	●	3/4"	-	50	402	188,20	1
C318070500		1 1/4"	●	3/4"	-	50	402	231,59	1
8 vie - 8 ways - 8 vías									
C319060500		1"	●	3/4"	-	50	452	210,38	1
C319070500		1 1/4"	●	3/4"	-	50	452	266,71	1
9 vie - 9 ways - 9 vías									
C320060500		1"	●	3/4"	-	50	502	232,27	1
C320070500		1 1/4"	●	3/4"	-	50	502	298,41	1
10 vie - 10 ways - 10 vías									
C320160500		1"	●	3/4"	-	50	552	259,75	1
C320170500		1 1/4"	●	3/4"	-	50	552	322,66	1
11 vie - 11 ways - 11 vías									
C320260500		1"	●	3/4"	-	50	602	276,51	1
C320270500		1 1/4"	●	3/4"	-	50	602	352,32	1
12 vie - 12 ways - 12 vías									



Collettori da barra FF con attacchi 3/4" M eurocono con vitone termostatico e regolatori di flusso a scala graduata.

Staffe di supporto Art. 271

FF brass bar manifolds with 3/4" male Euroconus outlets, with thermostatic screw and flow meters. Manifold's brackets Art. 271

Colectores HH con empalmes 3/4" M eurocono con valvulas de regulacion termostaticas y caudalímetros. Soportes Art. 271

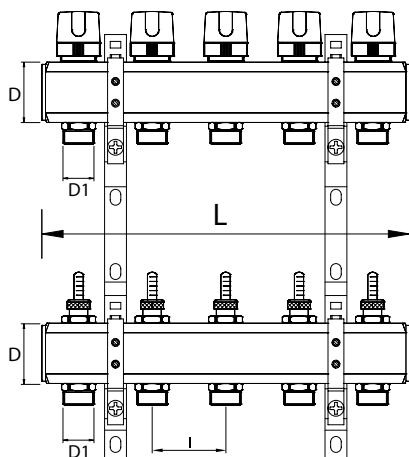
C322÷C3302

Code	Version	Size (D)	Smooth	D1	H	I	L	€	Pack
C322060500		1"	●	3/4"	-	50	102	70,15	1
C322070500		1 1/4"	●	3/4"	-	50	102	76,91	1
2 vie - 2 ways - 2 vías									
C323060500		1"	●	3/4"	-	50	152	104,92	1
C323070500		1 1/4"	●	3/4"	-	50	152	116,32	1
3 vie - 3 ways - 3 vías									
C324060500		1"	●	3/4"	-	50	202	133,93	1
C324070500		1 1/4"	●	3/4"	-	50	202	152,42	1
4 vie - 4 ways - 4 vías									
C325060500		1"	●	3/4"	-	50	252	163,19	1
C325070500		1 1/4"	●	3/4"	-	50	252	186,56	1
5 vie - 5 ways - 5 vías									
C326060500		1"	●	3/4"	-	50	302	190,61	1
C326070500		1 1/4"	●	3/4"	-	50	302	218,03	1
6 vie - 6 ways - 6 vías									
C327060500		1"	●	3/4"	-	50	352	221,71	1
C327070500		1 1/4"	●	3/4"	-	50	352	248,21	1
7 vie - 7 ways - 7 vías									
C328060500		1"	●	3/4"	-	50	402	249,97	1
C328070500		1 1/4"	●	3/4"	-	50	402	281,65	1
8 vie - 8 ways - 8 vías									
C329060500		1"	●	3/4"	-	50	452	280,23	1
C329070500		1 1/4"	●	3/4"	-	50	452	323,88	1
9 vie - 9 ways - 9 vías									
C330060500		1"	●	3/4"	-	50	502	312,09	1
C330070500		1 1/4"	●	3/4"	-	50	502	362,72	1
10 vie - 10 ways - 10 vías									
C330160500		1"	●	3/4"	-	50	552	339,99	1
C330170500		1 1/4"	●	3/4"	-	50	552	394,78	1
11 vie - 11 ways - 11 vías									
C330260500		1"	●	3/4"	-	50	602	372,72	1
C330270500		1 1/4"	●	3/4"	-	50	602	429,78	1
12 vie - 12 ways - 12 vías									



Collettore FF con uscite
3/4" M Eurocono e
detentori di regolazione

*FF manifold with 3/4" M
Euroconus outlets
and lockshield valves*

*Colector HH con
empalmes 3/4" M
Eurocono y detentores*

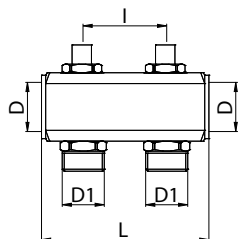
332D÷340D

Code	Version	Size (D)	Smooth	D1	H	I	L	€	Pack
2 vie - 2 ways - 2 vías									
332D060500		1"	●	3/4"	-	50	102	21,44	1
332D070500		1 1/4"	●	3/4"	-	50	102	26,70	1
3 vie - 3 ways - 3 vías									
333D060500		1"	●	3/4"	-	50	152	31,13	1
333D070500		1 1/4"	●	3/4"	-	50	152	38,99	1
4 vie - 4 ways - 4 vías									
334D060500		1"	●	3/4"	-	50	202	41,25	1
334D070500		1 1/4"	●	3/4"	-	50	202	51,89	1
5 vie - 5 ways - 5 vías									
335D060500		1"	●	3/4"	-	50	252	51,39	1
335D070500		1 1/4"	●	3/4"	-	50	252	64,46	1
6 vie - 6 ways - 6 vías									
336D060500		1"	●	3/4"	-	50	302	61,42	1
336D070500		1 1/4"	●	3/4"	-	50	302	76,14	1
7 vie - 7 ways - 7 vías									
337D060500		1"	●	3/4"	-	50	352	71,77	1
337D070500		1 1/4"	●	3/4"	-	50	352	89,43	1
8 vie - 8 ways - 8 vías									
338D060500		1"	●	3/4"	-	50	402	81,11	1
338D070500		1 1/4"	●	3/4"	-	50	402	101,74	1
9 vie - 9 ways - 9 vías									
339D060500		1"	●	3/4"	-	50	452	91,99	1
339D070500		1 1/4"	●	3/4"	-	50	452	117,81	1
10 vie - 10 ways - 10 vías									
340D060500		1"	●	3/4"	-	50	502	101,98	1
340D070500		1 1/4"	●	3/4"	-	50	502	129,34	1
11 vie - 11 ways - 11 vías									
340D260500		1"	●	3/4"	-	50	602	122,21	1
340D270500		1 1/4"	●	3/4"	-	50	602	155,65	1
12 vie - 12 ways - 12 vías									



Collettore FF con uscite
3/4" M Eurocono e
misuratori di portata

*FF manifold with 3/4" M
Euroconus outlets
with flow meters*

*Colector HH con
empalmes 3/4"
M Eurocono y
caudalímetros*

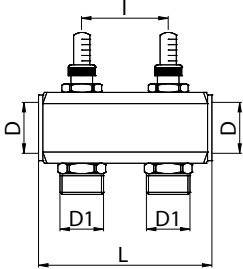
332M÷340M

Code	Version	Size (D)	Smooth	D1	H	I	L	€	Pack
332M060500		1"	●	3/4"	-	50	102	33,98	1
332M070500		1 1/4"	●	3/4"	-	50	102	39,19	1
2 vie - 2 ways - 2 vías									
333M060500		1"	●	3/4"	-	50	152	51,16	1
333M070500		1 1/4"	●	3/4"	-	50	152	57,99	1
3 vie - 3 ways - 3 vías									
334M060500		1"	●	3/4"	-	50	202	67,49	1
334M070500		1 1/4"	●	3/4"	-	50	202	77,49	1
4 vie - 4 ways - 4 vías									
335M060500		1"	●	3/4"	-	50	252	84,30	1
335M070500		1 1/4"	●	3/4"	-	50	252	100,20	1
5 vie - 5 ways - 5 vías									
336M060500		1"	●	3/4"	-	50	302	101,10	1
336M070500		1 1/4"	●	3/4"	-	50	302	117,05	1
6 vie - 6 ways - 6 vías									
337M060500		1"	●	3/4"	-	50	352	117,53	1
337M070500		1 1/4"	●	3/4"	-	50	352	135,67	1
7 vie - 7 ways - 7 vías									
338M060500		1"	●	3/4"	-	50	402	133,75	1
338M070500		1 1/4"	●	3/4"	-	50	402	156,02	1
8 vie - 8 ways - 8 vías									
339M060500		1"	●	3/4"	-	50	452	150,48	1
339M070500		1 1/4"	●	3/4"	-	50	452	179,91	1
9 vie - 9 ways - 9 vías									
340M060500		1"	●	3/4"	-	50	502	167,40	1
340M070500		1 1/4"	●	3/4"	-	50	502	201,61	1
10 vie - 10 ways - 10 vías									
340M160500		1"	●	3/4"	-	50	552	185,57	1
340M170500		1 1/4"	●	3/4"	-	50	552	218,96	1
11 vie - 11 ways - 11 vías									
340M260500		1"	●	3/4"	-	50	602	204,36	1
340M270500		1 1/4"	●	3/4"	-	50	602	240,03	1
12 vie - 12 ways - 12 vías									



Collettore FF con uscite 3/4" M eurocono con vitoni termostaticizzabili e cappucci di protezione

FF manifold with 3/4" M Euroconus outlets with thermostatic valves and protection caps

Colector HH con empalmes 3/4" M eurocono, válvulas de regulación termostaticizables y capuchon de protección

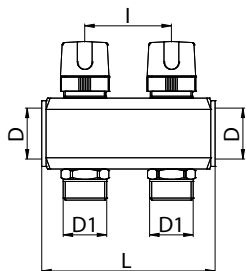

332T÷340T

Code	Version	Size (D)	Smooth	D1	H	I	L	€	Pack
332T060500		1"	●	3/4"	-	50	102	24,99	1
332T070500		1 1/4"	●	3/4"	-	50	102	31,10	1
2 vie - 2 ways - 2 vías									
333T060500		1"	●	3/4"	-	50	152	37,61	1
333T070500		1 1/4"	●	3/4"	-	50	152	46,34	1
3 vie - 3 ways - 3 vías									
334T060500		1"	●	3/4"	-	50	202	49,71	1
334T070500		1 1/4"	●	3/4"	-	50	202	61,20	1
4 vie - 4 ways - 4 vías									
335T060500		1"	●	3/4"	-	50	252	62,01	1
335T070500		1 1/4"	●	3/4"	-	50	252	76,46	1
5 vie - 5 ways - 5 vías									
336T060500		1"	●	3/4"	-	50	302	73,45	1
336T070500		1 1/4"	●	3/4"	-	50	302	91,71	1
6 vie - 6 ways - 6 vías									
337T060500		1"	●	3/4"	-	50	352	85,78	1
337T070500		1 1/4"	●	3/4"	-	50	352	106,41	1
7 vie - 7 ways - 7 vías									
338T060500		1"	●	3/4"	-	50	402	97,97	1
338T070500		1 1/4"	●	3/4"	-	50	402	121,64	1
8 vie - 8 ways - 8 vías									
339T060500		1"	●	3/4"	-	50	452	110,15	1
339T070500		1 1/4"	●	3/4"	-	50	452	139,29	1
9 vie - 9 ways - 9 vías									
340T060500		1"	●	3/4"	-	50	502	122,26	1
340T070500		1 1/4"	●	3/4"	-	50	502	151,76	1
10 vie - 10 ways - 10 vías									
340T160500		1"	●	3/4"	-	50	552	135,00	1
340T170500		1 1/4"	●	3/4"	-	50	552	168,40	1
11 vie - 11 ways - 11 vías									
340T260500		1"	●	3/4"	-	50	602	147,34	1
340T270500		1 1/4"	●	3/4"	-	50	602	182,68	1
12 vie - 12 ways - 12 vías									

Gruppo di miscelazione a punto fisso | Fixed point regulation kit

Temperatura massima d'esercizio / Max working temperature: 70°C

Pressione massima d'esercizio / Max working pressure: 6 bar

Filetti / Threads: ISO 228

Fluidi ammessi: Acqua (percentuale massima di glicole: 50%) / Allowed fluids: water (Glycole max percentage: 50%)

Temperatura di regolazione / Temperature settings: 20°C-55°C (art. C301) - 35°C-55°C (art. C307K-C307KA)

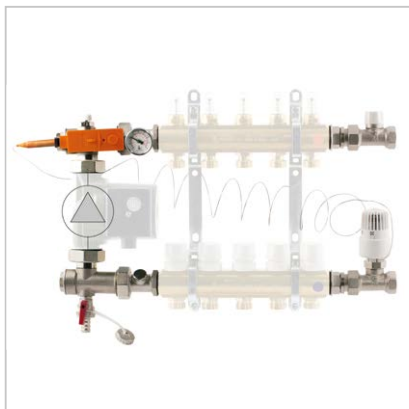
C301

Code	Version	Size (D)	Smooth	D1	H	I	L	€	Pack
C301000D00		-	-	-	-	-	-	227,39	1

Kit regolazione termica a punto fisso per pannelli radianti

Fixed point regulating kit for radiant panels
Kit de regulaci3n con punto fijo para paneles radiantes

C307K

Code	Version	Size (D)	Smooth	D1	H	I	L	€	Pack
C307K00000		1"	-	-	130	-	157	171,30	1

Kit premontato a punto fisso per bassa temperatura

Fixed point regulation kit low temperature
Kit premontado con punto fijo para baja temperatura

Nel caso di utilizzo di pompa non a controllo elettronico utilizzare il kit di by-pass art. C308KB

If used with a pump not electronically controlled add the by-pass kit art. C308KB

C308KB

Code	Version	Size (D)	Smooth	D1	H	I	L	€	Pack
C308KB000R		1/2"	-	3/8"	-	-	-	16,62	1

Kit by-pass eccentrico

Off-centre by-pass kit
Kit by-pass excentrico

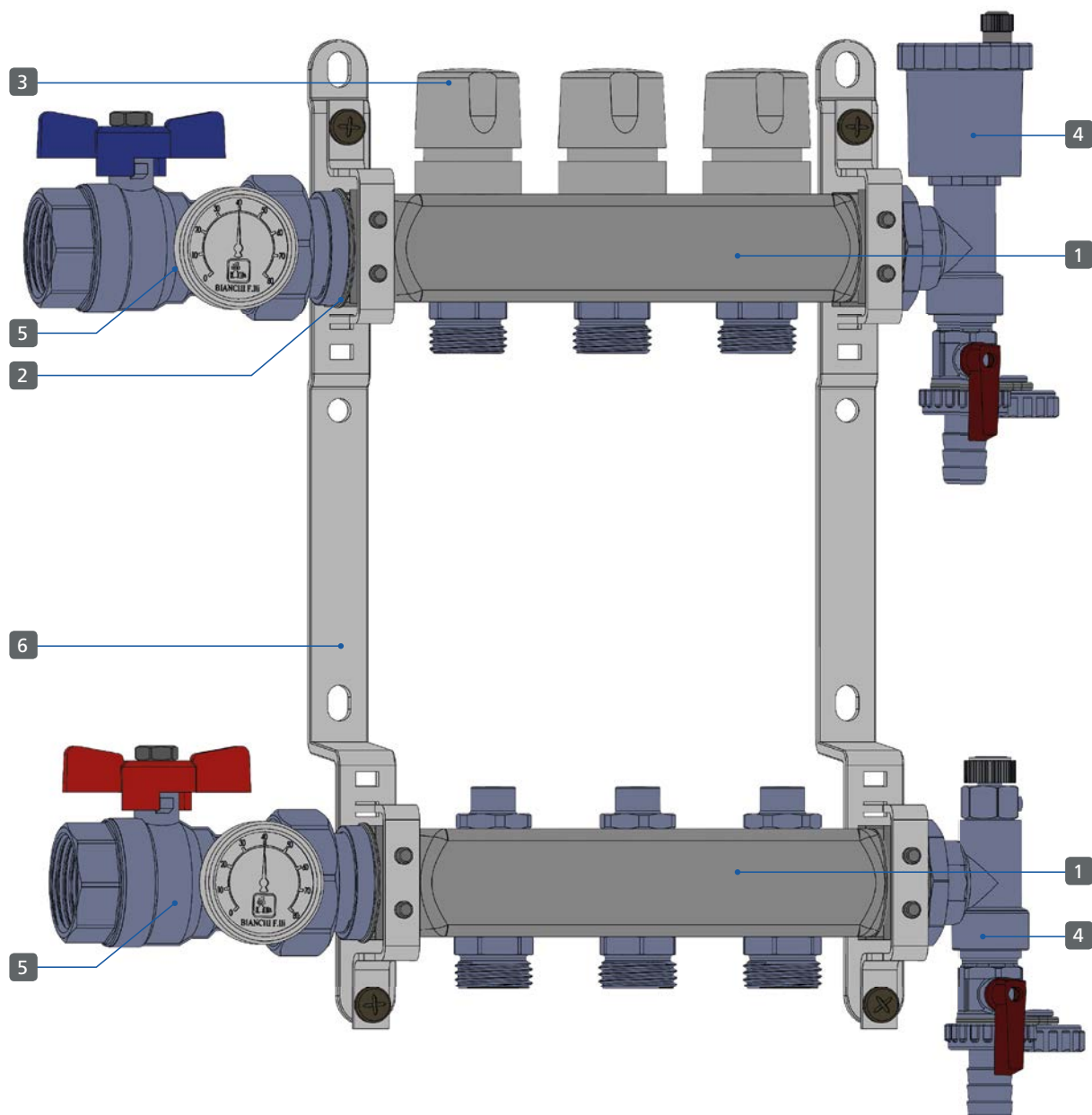
Collettori premontati in acciaio inox | Pre-assembled stainless steel manifolds

Scheda materiali | Materials

Denominazione	Pz.	Materiale
1 Collettore / Manifold	2	ACCIAIO INOX / STAINLESS STEEL AISI 304L
2 O-ring / O-ring	-	EPDM / VITON
3 Volantino / Handle wheels	-	ABS
4 Terminale / Terminal part	2	OTTONE / BRASS CW617N
5 Valvola a sfera / Ball valve	2	OTTONE / BRASS CW617N
6 Staffa di fissaggio / Mounting Bracket	2	ACCIAIO / STEEL

• Caratteristiche generali / General informations

Temperatura d'esercizio / Working temperature: 5-80°C

Pressione massima d'esercizio / Max working pressure: 10 bar

Filetti / Threads: ISO 228

Adatti per raccordi tubo rame, PEX, multistrato / Suitable for fittings for copper, PEX or multilayer piping

Fluidi ammessi: Acqua (percentuale massima di glicole: 50%) / Allowed fluids: water (Glycole max percentage: 50%)

Abbinabili agli attuatori / Available with actuators: art.350-351

Le valvole a sfera devono essere utilizzate in posizione totalmente aperta-chiusa / Ball valves must be used in totally open-close position

I collettori vengono forniti già montati sulle staffe di supporto; gli accessori saranno forniti smontati all'interno della stessa scatola / Manifolds will be supplied mounted on the brackets; accessories will be supplied separately, inside the same box

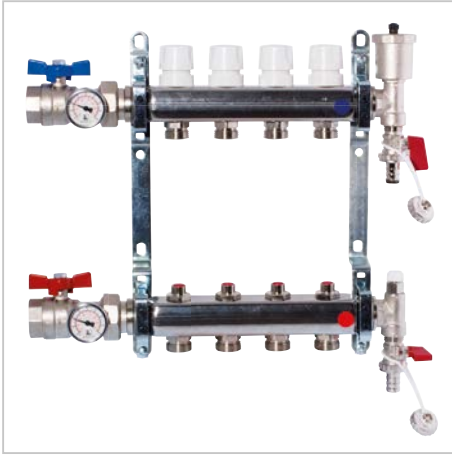

Collettori FF in acciaio AISI 304L con attacchi 3/4" M Eurocono, con vitoni termostatici e detentori. Valvole a sfera con termometro Art. 422M, staffe di supporto ART. 271 e terminali per collettori ART. 2980N e ART. 2990N.

FF stainless steel AISI 304L manifolds with 3/4" M Euroconus outlets, with thermostatic screws and lockshield valves. Ball valves thermometer included Art. 422M, manifold's brackets ART. 271 and terminal parts for manifolds ART. 2980N and 2990N.

Colectores HH de acero AISI 304L con empalmes 3/4" M Eurocono con valvula de regulacion termostaticables y detentores. Valvula de bola con termometro incorporado Art. 422M, soportes Art. 271 y tapones terminales Art. 2980N y 2990N.

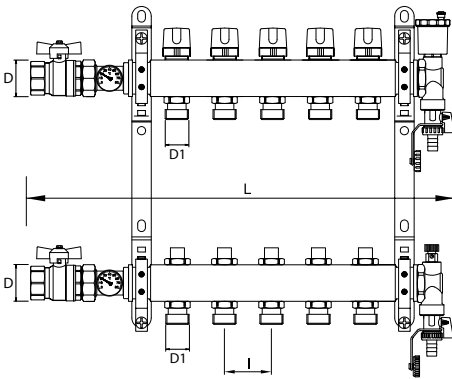

A332AA÷A3402AA

Code	Version	Size (D)	Smooth	D1	H	I	L	€	Pack
A332A6050A		1"	●	3/4"	-	50	291	142,11	1
2 vie - 2 ways - 2 vías									
A333A6050A		1"	●	3/4"	-	50	341	166,54	1
3 vie - 3 ways - 3 vías									
A334A6050A		1"	●	3/4"	-	50	391	183,50	1
4 vie - 4 ways - 4 vías									
A335A6050A		1"	●	3/4"	-	50	441	202,09	1
5 vie - 5 ways - 5 vías									
A336A6050A		1"	●	3/4"	-	50	491	220,12	1
6 vie - 6 ways - 6 vías									
A337A6050A		1"	●	3/4"	-	50	541	241,25	1
7 vie - 7 ways - 7 vías									
A338A6050A		1"	●	3/4"	-	50	591	259,52	1
8 vie - 8 ways - 8 vías									
A339A6050A		1"	●	3/4"	-	50	641	278,71	1
9 vie - 9 ways - 9 vías									
A340A6050A		1"	●	3/4"	-	50	691	296,60	1
10 vie - 10 ways - 10 vías									
A340A6150A		1"	●	3/4"	-	50	741	315,25	1
11 vie - 11 ways - 11 vías									
A340A6250A		1"	●	3/4"	-	50	791	334,68	1
12 vie - 12 ways - 12 vías									

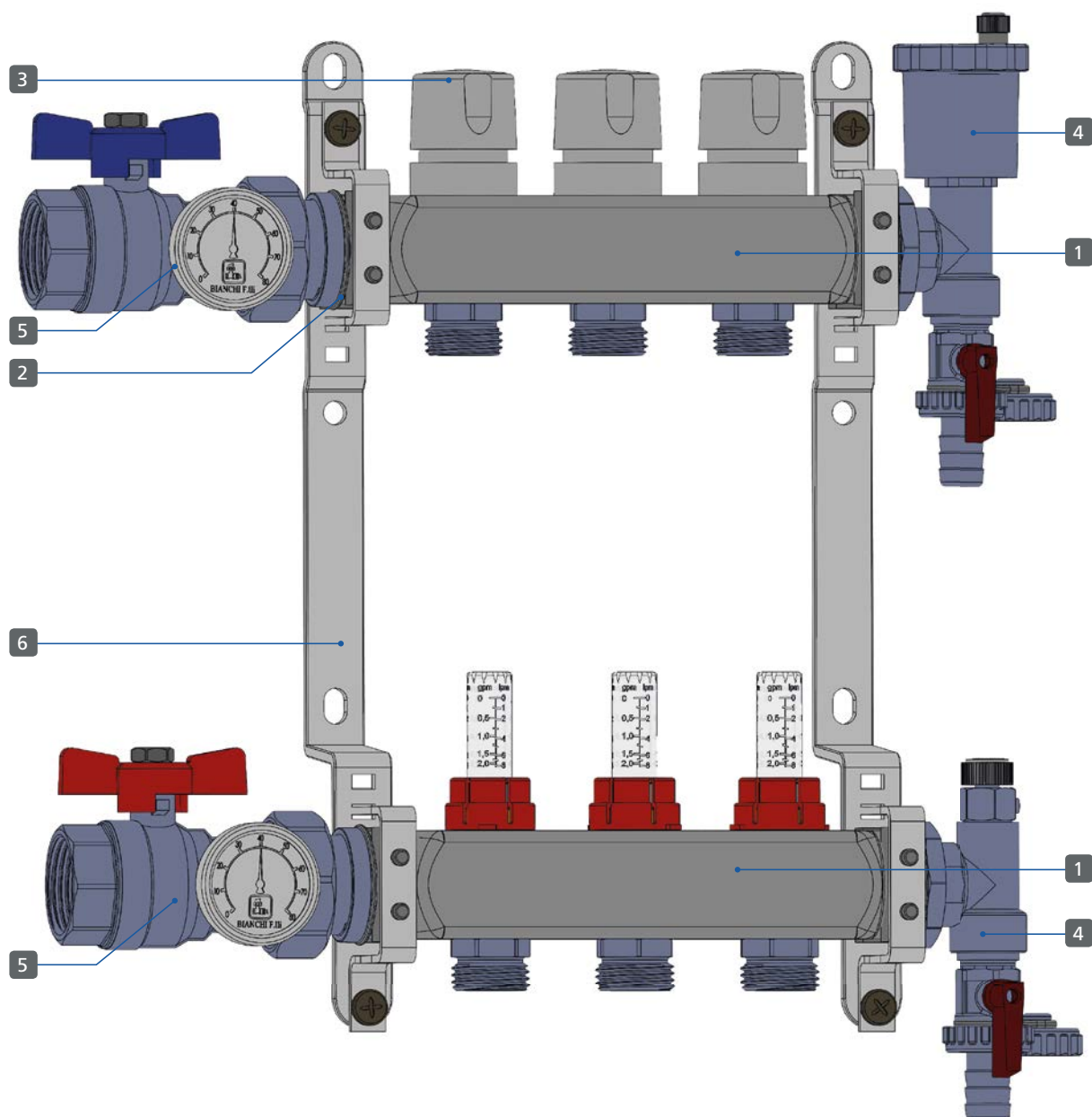

Scheda materiali | Materials

Denominazione	Pz.	Materiale
1 Collettore / Manifold	2	ACCIAIO INOX / STAINLESS STEEL AISI 304L
2 O-ring / O-ring	-	EPDM / VITON
3 Volantino / Handle wheels	-	ABS
4 Terminale / Terminal part	2	OTTONE / BRASS CW617N
5 Valvola a sfera / Ball valve	2	OTTONE / BRASS CW617N
6 Staffa di fissaggio / Mounting Bracket	2	ACCIAIO / STEEL

• Caratteristiche generali / General informations

Temperatura d'esercizio / Working temperature: 5-70°C

Pressione massima d'esercizio / Max working pressure: 6 bar

Filetti / Threads: ISO 228

Scala Flussimetro / Flowmeter scale: 0-8 l/min

Adatti per raccordi tubo rame, PEX, multistrato / Suitable for fittings for copper, PEX or multilayer piping

Fluidi ammessi: Acqua (percentuale massima di glicole: 50%) / Allowed fluids: water (Glycole max percentage: 50%)

Abbinabili agli attuatori / Available with actuators: art.350-351

Le valvole a sfera devono essere utilizzate in posizione totalmente aperta-chiusa / Ball valves must be used in totally open-close position

I collettori vengono forniti già montati sulle staffe di supporto; gli accessori saranno forniti smontati all'interno della stessa scatola / Manifolds will be supplied mounted on the brackets; accessories will be supplied separately, inside the same box



Collettori FF in acciaio AISI 304L con attacchi 3/4" M Eurocono, con vitoni termostatici e misuratori di portata. Valvole a sfera con termometro ART. 422M, staffe di supporto ART. 271 e terminali per collettore ART. 2980N e ART. 2990N.

FF stainless steel AISI 304L manifolds with 3/4" M Euroconus outlets, with thermostatic screw and flow meters. Ball valves with thermometer included ART. 422M, manifold's brackets ART. 271 and terminal parts for manifolds ART. 2980N and 2990N.

Colectores HH de acero AISI 304L con empalmes 3/4" M Eurocono con valvulas de regulacion termostaticables y caudalímetros. Válvula de bola con termómetro incorporado Art. 422M, soportes Art. 271 y tapones terminales Art. 2980N y 2990N.

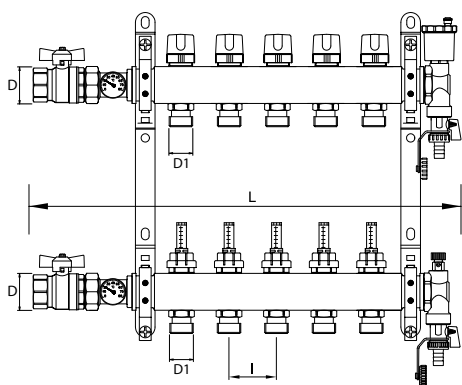
A342AA÷A3502AA

Code	Version	Size (D)	Smooth	D1	H	I	L	€	Pack
A342A6050A		1"	●	3/4"	-	50	291	157,49	1
2 vie - 2 ways - 2 vías									
A343A6050A		1"	●	3/4"	-	50	341	180,24	1
3 vie - 3 ways - 3 vías									
A344A6050A		1"	●	3/4"	-	50	391	202,77	1
4 vie - 4 ways - 4 vías									
A345A6050A		1"	●	3/4"	-	50	441	225,89	1
5 vie - 5 ways - 5 vías									
A346A6050A		1"	●	3/4"	-	50	491	250,50	1
6 vie - 6 ways - 6 vías									
A347A6050A		1"	●	3/4"	-	50	541	277,16	1
7 vie - 7 ways - 7 vías									
A348A6050A		1"	●	3/4"	-	50	591	300,98	1
8 vie - 8 ways - 8 vías									
A349A6050A		1"	●	3/4"	-	50	641	325,73	1
9 vie - 9 ways - 9 vías									
A350A6050A		1"	●	3/4"	-	50	691	349,18	1
10 vie - 10 ways - 10 vías									
A350A6150A		1"	●	3/4"	-	50	741	373,39	1
11 vie - 11 ways - 11 vías									
A350A6250A		1"	●	3/4"	-	50	791	398,36	1
12 vie - 12 ways - 12 vías									



Collettori FF in acciaio AISI 304L con attacchi 3/4" M Eurocono, con vitoni termostatici e detentori di regolazione. Staffe di supporto Art. 271 e terminali per collettori Art. 2980N e Art. 2990N.

FF stainless steel AISI 304L manifolds with 3/4" M Euroconus outlets, with thermostatic screws and lockshield valves. Manifold's brackets Art. 271 and terminal parts for manifolds Art. 2980N and 2990N.

Colectores HH de acero AISI 304L con empalmes 3/4" M Eurocono con valvula de regulacion termostaticas y detentores. Soportes Art. 271 y tapones terminales Art. 2980N y 2990N.

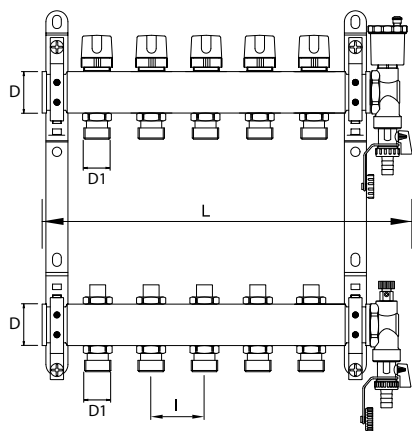
A332A÷A3402A

Code	Version	Size (D)	Smooth	D1	H	I	L	€	Pack
A33206050A		1"	●	3/4"	-	50	195	98,81	1
2 vie - 2 ways - 2 vías									
A33306050A		1"	●	3/4"	-	50	245	117,80	1
3 vie - 3 ways - 3 vías									
A33406050A		1"	●	3/4"	-	50	295	135,65	1
4 vie - 4 ways - 4 vías									
A33506050A		1"	●	3/4"	-	50	345	154,49	1
5 vie - 5 ways - 5 vías									
A33606050A		1"	●	3/4"	-	50	395	174,03	1
6 vie - 6 ways - 6 vía									
A33706050A		1"	●	3/4"	-	50	445	192,83	1
7 vie - 7 ways - 7 vías									
A33806050A		1"	●	3/4"	-	50	495	211,35	1
8 vie - 8 ways - 8 vías									
A33906050A		1"	●	3/4"	-	50	545	228,88	1
9 vie - 9 ways - 9 vías									
A34006050A		1"	●	3/4"	-	50	595	247,65	1
10 vie - 10 ways - 10 vías									
A34016050A		1"	●	3/4"	-	50	645	266,54	1
11 vie - 11 ways - 11 vías									
A34026050A		1"	●	3/4"	-	50	695	289,92	1
12 vie - 12 ways - 12 vías									



Collettori FF in acciaio AISI 304L con attacchi 3/4" M Eurocono, con vitoni termostatici e misuratori di portata. Staffe di supporto Art. 271 e terminali per collettori Art. 2980N e 2990N.

FF stainless steel AISI 304L manifolds with 3/4" male Euroconus outlets, with thermostatic screws and flow meters. Manifold's brackets Art. 271 and terminal parts for manifolds ART. 2980N and 2990N.

Colectores HH de acero AISI 304L con empalmes 3/4" M Eurocono con valvula de regulacion termostaticables y caudalímetros. Soportes Art. 271 y tapones terminales Art. 2980N y 2990N.

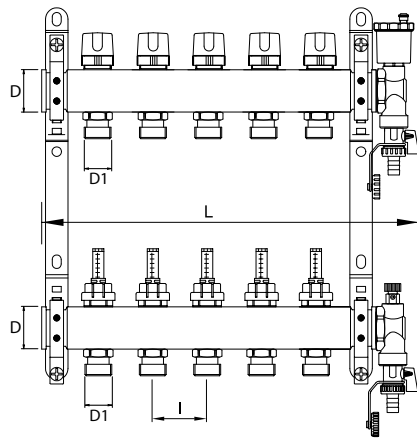
A342A÷A3502A

Code	Version	Size (D)	Smooth	D1	H	I	L	€	Pack
A34206050A		1"	●	3/4"	-	50	195	110,35	1
2 vie - 2 ways - 2 vías									
A34306050A		1"	●	3/4"	-	50	245	133,12	1
3 vie - 3 ways - 3 vías									
A34406050A		1"	●	3/4"	-	50	295	156,70	1
4 vie - 4 ways - 4 vías									
A34506050A		1"	●	3/4"	-	50	345	179,82	1
5 vie - 5 ways - 5 vías									
A34606050A		1"	●	3/4"	-	50	395	207,62	1
6 vie - 6 ways - 6 vías									
A34706050A		1"	●	3/4"	-	50	445	231,09	1
7 vie - 7 ways - 7 vías									
A34806050A		1"	●	3/4"	-	50	495	254,92	1
8 vie - 8 ways - 8 vías									
A34906050A		1"	●	3/4"	-	50	545	279,66	1
9 vie - 9 ways - 9 vías									
A35006050A		1"	●	3/4"	-	50	595	303,10	1
10 vie - 10 ways - 10 vías									
A35016050A		1"	●	3/4"	-	50	645	328,38	1
11 vie - 11 ways - 11 vías									
A35026050A		1"	●	3/4"	-	50	695	359,72	1
12 vie - 12 ways - 12 vías									

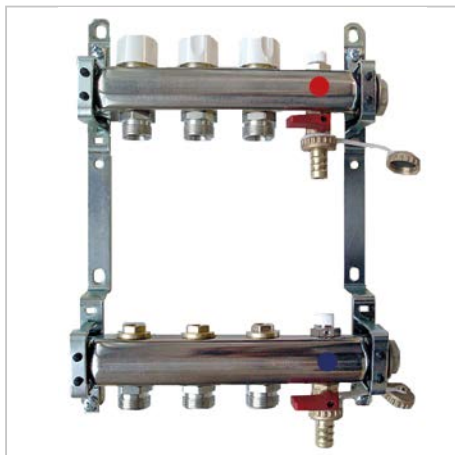

Collettori FF in acciaio AISI 304L con attacchi 3/4" M Eurocono, con viti termostatici e detentori di regolazione. Valvola sfiato aria ART. 418CR, rubinetto di scarico ART. 476CS e staffe di supporto Art. 271.

FF stainless steel AISI 304L manifolds with 3/4" male Euroconus outlets, with thermostatic screws and lockshield valves. Air discharge valve ART. 418CR, drain ball valve ART. 476CS and manifold's brackets Art. 271.

Colectores HH de acero AISI 304L con empalmes 3/4" M Eurocono con valvula de regulacion termostaticables y detentores. Valvula de descarga de aire Art. 418CR, llave de bola evacuación caldera Art. 476CS y soportes Art. 271.

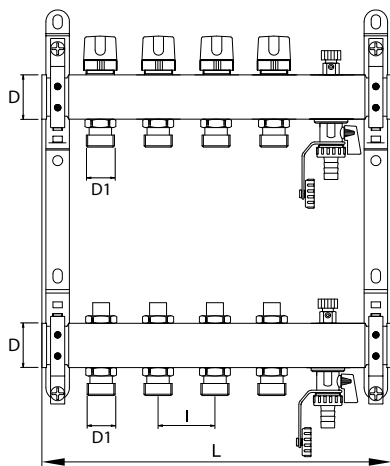
A332÷A3402

Code	Version	Size (D)	Smooth	D1	H	I	L	€	Pack
A332060500		1"	●	3/4"	-	50	143	98,51	1
2 vie - 2 ways - 2 vías									
A333060500		1"	●	3/4"	-	50	193	115,31	1
3 vie - 3 ways - 3 vías									
A334060500		1"	●	3/4"	-	50	243	133,71	1
4 vie - 4 ways - 4 vías									
A335060500		1"	●	3/4"	-	50	293	151,57	1
5 vie - 5 ways - 5 vías									
A336060500		1"	●	3/4"	-	50	343	172,49	1
6 vie - 6 ways - 6 vía									
A337060500		1"	●	3/4"	-	50	393	190,59	1
7 vie - 7 ways - 7 vías									
A338060500		1"	●	3/4"	-	50	443	209,59	1
8 vie - 8 ways - 8 vías									
A339060500		1"	●	3/4"	-	50	493	227,30	1
9 vie - 9 ways - 9 vías									
A340060500		1"	●	3/4"	-	50	543	245,77	1
10 vie - 10 ways - 10 vías									
A340160500		1"	●	3/4"	-	50	593	265,01	1
11 vie - 11 ways - 11 vías									
A340260500		1"	●	3/4"	-	50	643	291,14	1
12 vie - 12 ways - 12 vías									

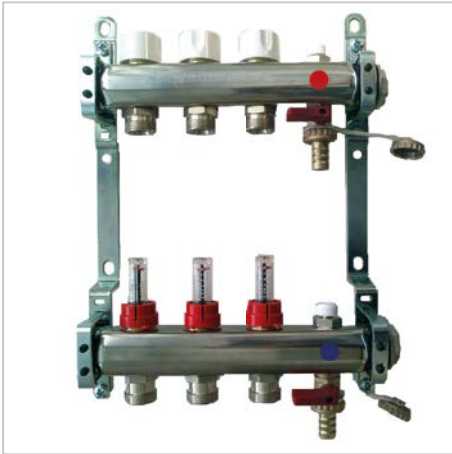

Collettori FF in acciaio AISI 304L con attacchi 3/4" M Eurocono, con vitoni termostatici e misuratori di portata. Valvola sfiato aria ART. 418CR, rubinetto di scarico ART. 476CS, staffe di supporto Art. 271, tappi 1" Art. 231.

FF stainless steel AISI 304L manifolds with 3/4" male Euroconus outlets, with thermostatic screws and flow meters. Air discharge valve ART. 418CR, drain ball valve ART. 476CS, manifold's brackets Art. 271, taps 1" Art. 231.

Colectores HH de acero AISI 304L con empalmes 3/4" M Eurocono con valvola de regulacion termostaticables y caudalímetros. Valvula de descarga de aire cromada ART. 418CR, llave de bola evacuación ART. 476CS, soportes Art. 271, tapón 1" Art. 231.

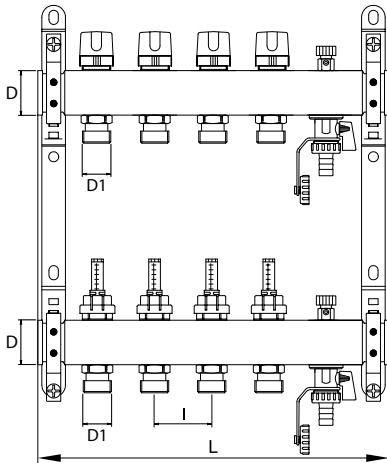

A342÷A3502

Code	Version	Size (D)	Smooth	D1	H	I	L	€	Pack
A342060500		1"	●	3/4"	-	50	143	108,10	1
2 vie - 2 ways - 2 vías									
A343060500		1"	●	3/4"	-	50	193	130,62	1
3 vie - 3 ways - 3 vías									
A344060500		1"	●	3/4"	-	50	243	154,75	1
4 vie - 4 ways - 4 vías									
A345060500		1"	●	3/4"	-	50	293	177,33	1
5 vie - 5 ways - 5 vías									
A346060500		1"	●	3/4"	-	50	343	205,01	1
6 vie - 6 ways - 6 vías									
A347060500		1"	●	3/4"	-	50	393	228,84	1
7 vie - 7 ways - 7 vías									
A348060500		1"	●	3/4"	-	50	443	253,58	1
8 vie - 8 ways - 8 vías									
A349060500		1"	●	3/4"	-	50	493	277,02	1
9 vie - 9 ways - 9 vías									
A350060500		1"	●	3/4"	-	50	543	301,24	1
10 vie - 10 ways - 10 vías									
A350160500		1"	●	3/4"	-	50	593	326,22	1
11 vie - 11 ways - 11 vías									
A350260500		1"	●	3/4"	-	50	643	358,07	1
12 vie - 12 ways - 12 vías									



Collettori FF in acciaio AISI 304L con attacchi 3/4" M Eurocono, con viti termostatiche e detentori di regolazione. Staffe di supporto Art. 271.

FF stainless steel AISI 304L manifolds with 3/4" male Euroconus outlets, with thermostatic valves and lockshield valves. Manifold's brackets Art. 271.

Colectores HH de acero AISI 304L con empalmes 3/4" M Eurocono con valvulas del regulacion termostaticables y detentores. Soportes Art. 271.

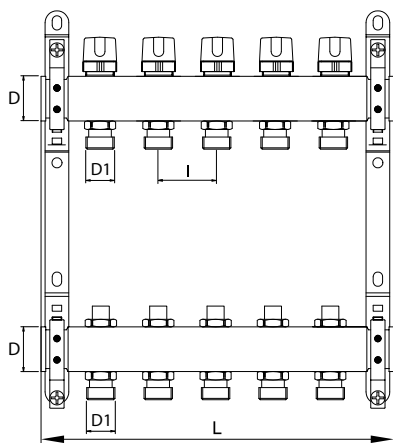
A312÷A3202

Code	Version	Size (D)	Smooth	D1	H	I	L	€	Pack
A312060500		1"	●	3/4"	-	50	143	66,43	1
2 vie - 2 ways - 2 vías									
A313060500		1"	●	3/4"	-	50	193	82,53	1
3 vie - 3 ways - 3 vías									
A314060500		1"	●	3/4"	-	50	243	102,54	1
4 vie - 4 ways - 4 vías									
A315060500		1"	●	3/4"	-	50	293	122,44	1
5 vie - 5 ways - 5 vías									
A316060500		1"	●	3/4"	-	50	343	141,86	1
6 vie - 6 ways - 6 vías									
A317060500		1"	●	3/4"	-	50	393	164,26	1
7 vie - 7 ways - 7 vías									
A318060500		1"	●	3/4"	-	50	443	183,92	1
8 vie - 8 ways - 8 vías									
A319060500		1"	●	3/4"	-	50	493	204,43	1
9 vie - 9 ways - 9 vías									
A320060500		1"	●	3/4"	-	50	543	223,79	1
10 vie - 10 ways - 10 vías									
A320160500		1"	●	3/4"	-	50	593	243,66	1
11 vie - 11 ways - 11 vías									
A320260500		1"	●	3/4"	-	50	643	261,85	1
12 vie - 12 ways - 12 vías									



Collettori FF in acciaio AISI 304L con attacchi 3/4" M Eurocono, con vitoni termostatici e misuratori di portata. Staffe di supporto Art. 271.

FF stainless steel AISI 304L manifolds with 3/4" male Euroconus outlets, with thermostatic valves and flow meters. Manifold's brackets Art. 271.

Colectores FF de acero AISI 304L con empalmes 3/4" M Eurocono con valvulas del regulacion termostaticables y caudalímetros. Soportes Art. 271.

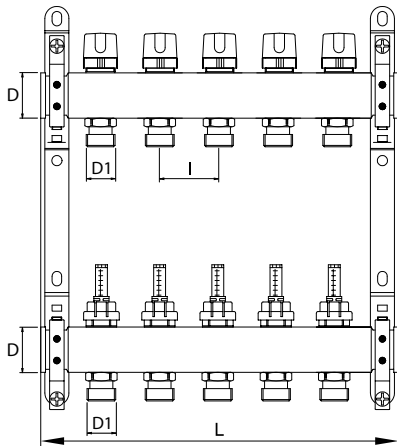

A322÷A3302

Code	Version	Size (D)	Smooth	D1	H	I	L	€	Pack
A322060500		1"	●	3/4"	-	50	143	76,87	1
2 vie - 2 ways - 2 vías									
A323060500		1"	●	3/4"	-	50	193	101,01	1
3 vie - 3 ways - 3 vías									
A324060500		1"	●	3/4"	-	50	243	124,98	1
4 vie - 4 ways - 4 vías									
A325060500		1"	●	3/4"	-	50	293	150,50	1
5 vie - 5 ways - 5 vías									
A326060500		1"	●	3/4"	-	50	343	175,51	1
6 vie - 6 ways - 6 vías									
A327060500		1"	●	3/4"	-	50	393	203,53	1
7 vie - 7 ways - 7 vías									
A328060500		1"	●	3/4"	-	50	443	228,80	1
8 vie - 8 ways - 8 vías									
A329060500		1"	●	3/4"	-	50	493	254,91	1
9 vie - 9 ways - 9 vías									
A330060500		1"	●	3/4"	-	50	543	279,79	1
10 vie - 10 ways - 10 vías									
A330160500		1"	●	3/4"	-	50	593	305,38	1
11 vie - 11 ways - 11 vías									
A330260500		1"	●	3/4"	-	50	643	331,71	1
12 vie - 12 ways - 12 vías									



Collettori FF in acciaio AISI 304L con uscite 3/4" M Eurocono e detentori di regolazione.

FF stainless steel AISI 304L manifold with 3/4" M Eurocono outlets and lockshield valves.

Colector de acero HH AISI 304L con empalmes 3/4" M Eurocono con detentores.

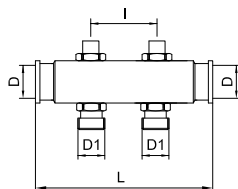

332DA÷3402DA

Code	Version	Size (D)	Smooth	D1	H	I	L	€	Pack
332DA60500		1"	●	3/4"	-	50	143	25,43	1
2 vie - 2 ways - 2 vías									
333DA60500		1"	●	3/4"	-	50	193	31,79	1
3 vie - 3 ways - 3 vías									
334DA60500		1"	●	3/4"	-	50	243	40,41	1
4 vie - 4 ways - 4 vías									
335DA60500		1"	●	3/4"	-	50	293	49,23	1
5 vie - 5 ways - 5 vías									
336DA60500		1"	●	3/4"	-	50	343	57,76	1
6 vie - 6 ways - 6 vías									
337DA60500		1"	●	3/4"	-	50	393	67,84	1
7 vie - 7 ways - 7 vías									
338DA60500		1"	●	3/4"	-	50	443	76,49	1
8 vie - 8 ways - 8 vías									
339DA60500		1"	●	3/4"	-	50	493	85,61	1
9 vie - 9 ways - 9 vías									
340DA60500		1"	●	3/4"	-	50	543	94,05	1
10 vie - 10 ways - 10 vías									
3401D6050A		1"	●	3/4"	-	50	593	102,91	1
11 vie - 11 ways - 11 vías									
3402D6050A		1"	●	3/4"	-	50	643	112,13	1
12 vie - 12 ways - 12 vías									



Collettori FF in acciaio
AISI 304L con uscite
3/4" M Eurocono e
misuratori di portata

*FF stainless steel AISI
304L manifold with
3/4" M Euroconus
outlets and flow meters*

*Colector de acero HH
AISI 304L con salidas
empalmes 3/4" M Euro-
cono con caudalímetros*

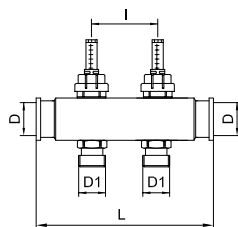
332MA÷3402MA

Code	Version	Size (D)	Smooth	D1	H	I	L	€	Pack
332MA60500		1"	●	3/4"	-	50	143	35,27	1
2 vie - 2 ways - 2 vías									
333MA60500		1"	●	3/4"	-	50	193	48,86	1
3 vie - 3 ways - 3 vías									
334MA60500		1"	●	3/4"	-	50	243	62,33	1
4 vie - 4 ways - 4 vías									
335MA60500		1"	●	3/4"	-	50	293	76,62	1
5 vie - 5 ways - 5 vías									
336MA60500		1"	●	3/4"	-	50	343	90,64	1
6 vie - 6 ways - 6 vías									
337MA60500		1"	●	3/4"	-	50	393	106,20	1
7 vie - 7 ways - 7 vías									
338MA60500		1"	●	3/4"	-	50	443	120,33	1
8 vie - 8 ways - 8 vías									
339MA60500		1"	●	3/4"	-	50	493	134,94	1
9 vie - 9 ways - 9 vías									
340MA60500		1"	●	3/4"	-	50	543	148,87	1
10 vie - 10 ways - 10 vías									
3401M6050A		1"	●	3/4"	-	50	593	163,20	1
11 vie - 11 ways - 11 vías									
3402M6050A		1"	●	3/4"	-	50	643	177,91	1
12 vie - 12 ways - 12 vías									



Collettori FF in acciaio AISI 304L con uscite 3/4" M Euroconus e vitoni termostatici e volantino micrometrico.

FF stainless steel AISI 304L manifold with 3/4" M Euroconus outlets and thermostatic screws and micrometric wheelhandle.

Colector de acero HH AISI 304L con salidas empalmes 3/4" M Euroconus con valvulas termostaticas y volantones micrometricos.

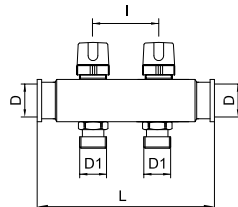

332TA÷3402TA

Code	Version	Size (D)	Smooth	D1	H	I	L	€	Pack
332TA60500		1"	●	3/4"	-	50	143	27,50	1
2 vie - 2 ways - 2 vías									
333TA60500		1"	●	3/4"	-	50	193	37,09	1
3 vie - 3 ways - 3 vías									
334TA60500		1"	●	3/4"	-	50	243	46,56	1
4 vie - 4 ways - 4 vías									
335TA60500		1"	●	3/4"	-	50	293	56,86	1
5 vie - 5 ways - 5 vías									
336TA60500		1"	●	3/4"	-	50	343	66,89	1
6 vie - 6 ways - 6 vías									
337TA60500		1"	●	3/4"	-	50	393	78,51	1
7 vie - 7 ways - 7 vías									
338TA60500		1"	●	3/4"	-	50	443	88,64	1
8 vie - 8 ways - 8 vías									
339TA60500		1"	●	3/4"	-	50	493	99,27	1
9 vie - 9 ways - 9 vías									
340TA60500		1"	●	3/4"	-	50	543	109,21	1
10 vie - 10 ways - 10 vías									
3401T6050A		1"	●	3/4"	-	50	593	119,55	1
11 vie - 11 ways - 11 vías									
3402T6050A		1"	●	3/4"	-	50	643	130,29	1
12 vie - 12 ways - 12 vías									

Cassette e supporti per collettori | Boxes and mounting brackets for manifolds

269



Code	Version	Size (D)	Smooth	D1	H	I	L	€	Pack
2690050000		500x630x110	-	-	-	-	-	117,29	1
2690070000		700x630x110	-	-	-	-	-	138,07	1
2690085000		850x630x110	-	-	-	-	-	152,54	1

Cassetta in lamiera verniciata per collettori con profondità regolabile

Regulating iron box for manifolds

Caja de inspección de chapa galvanizada barnizada de blanco para colectores

Scelta delle dimensioni della cassetta Art. 269 in relazione al numero delle derivazioni dei collettori premontati

Art. 269 dimension box selection in relation with the preassembled manifold outlets

	500	700	850
<p>Collettore standard <i>Standard manifold</i></p> <p>7+7</p> <p>Collettore con valvole e terminali <i>Manifold with valves and terminals</i></p> <p>5+5</p>		<p>Collettore standard <i>Standard manifold</i></p> <p>10+10</p> <p>Collettore con valvole e terminali <i>Manifold with valves and terminals</i></p> <p>8+8</p>	

**270**

Code	Version	Size (D)	Smooth	D1	H	I	L	€	Pack
2700035000		350x350x90	-	-	-	-	-	24,54	1
2700050000		500x350x90	-	-	-	-	-	30,87	1
2700065000		650x350x90	-	-	-	-	-	41,28	1

Cassetta in plastica per collettori

Plastic box for manifolds

Caja de plástico para colectores

Sceita delle dimensioni della cassetta Art. 270 in relazione al numero delle derivazioni dei collettori
Art. 270 dimension box selection in relation with the manifold outlets

350

Collettori con
interasse 36mm
*Manifolds with
interaxis 36mm*

7+7

Collettori con interasse
42mm o 50mm
*Manifolds with interaxis
42mm or 50mm*

6+6

500

Collettori con
interasse 36mm
*Manifolds with
interaxis 36mm*

10+10

Collettori con interasse
42mm o 50mm
*Manifolds with interaxis
42mm or 50mm*

8+8

650

Collettori con
interasse 36mm
*Manifolds with
interaxis 36mm*

14+14

Collettori con interasse
42mm o 50mm
*Manifolds with interaxis
42mm or 50mm*

12+12

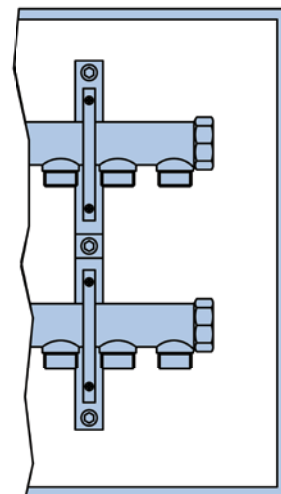
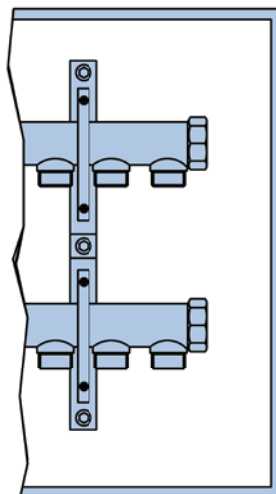
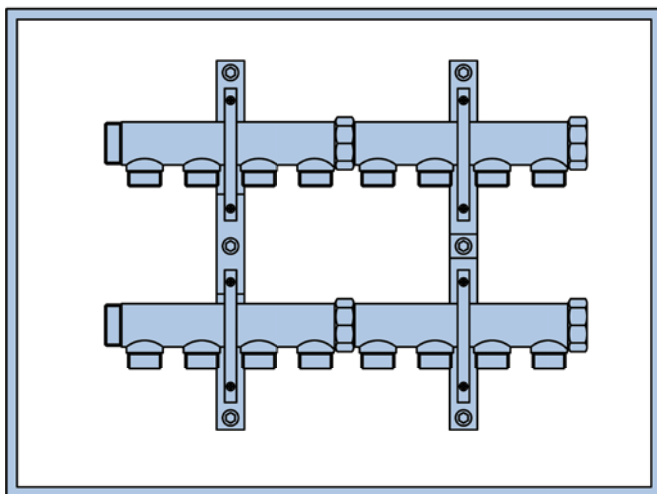
**270T**

Code	Version	Size (D)	Smooth	D1	H	I	L	€	Pack
270T035000		350x350	-	-	-	-	-	15,25	1
270T050000		500x350	-	-	-	-	-	17,55	1
270T065000		650x350	-	-	-	-	-	22,49	1

Coperchio per cassetta in plastica per collettori

Cover for plastic box for manifolds

Tapa para caja de plástico para colectores





Viti per cassette in
plastica
Screws for plastic box
*Tornillos para Caja de
plástico*

270VI

Code	Version	Size (D)	Smooth	D1	H	I	L	€	Pack
270VI00000		-		-	-	-	-	0,76	1



Kit fissaggio collettori
coplanari
*Double pattern
manifold's fixing set*
*Kit fijación colectores
coplanares modulares*

270CC

Code	Version	Size (D)	Smooth	D1	H	I	L	€	Pack
270CC00000		-		-	-	-	-	3,43	1



Kit fissaggio collettori
Manifold's fixing set
Kit fijación colectores

270CS

Code	Version	Size (D)	Smooth	D1	H	I	L	€	Pack
270CS00000		-		-	-	-	-	5,01	1



Staffa per collettori da
barra
*Support for brass bar
manifold*
Soportes para colectores

271

Code	Version	Size (D)	Smooth	D1	H	I	L	€	Pack
2710000500		3/4"	●	-	-	211	330	6,16	2
2710000000		1"	●	-	-	211	330	6,16	2
2710000700		1 1/4"	●	-	-	211	330	6,16	2

Il prezzo si riferisce ad un singolo pezzo / *The price is referred to one single piece*



Staffa singola
Single bracket
Individual soporte

271 S

Code	Version	Size (D)	Smooth	D1	H	I	L	€	Pack
271S000500		3/4"	●	-	-	-	-	4,18	2
271S000000		1"	●	-	-	-	-	4,18	2
271S000700		1 1/4"	●	-	-	-	-	4,18	2

Il prezzo si riferisce ad un singolo pezzo / *The price is referred to one single piece*

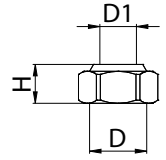
Tappi e raccordi per collettori | Plugs and fittings for manifolds

Riduzione per
collettore FF
*female-female reducer
for manifold*
*Reducción para
colector HH*

226

Code	Version	Size (D)	Smooth	D1	H	I	L	€	Pack
2260050300		3/4"	●	3/8"	17	-	-	1,60	50
2260C50300		3/4"	●	3/8"	17	-	-	1,70	50
2260060300		1"	●	3/8"	19	-	-	2,25	50
2260C60300		1"	●	3/8"	19	-	-	2,39	50

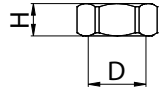

Tappo femmina con
guarnizione per
collettore
*Female plug for
manifold
with sealing*
*Tapón hembra para
colector
con junta*

227

Code	Version	Size (D)	Smooth	D1	H	I	L	€	Pack
2270000400		1/2"	●	-	12	-	-	0,86	50
2270C00400		1/2"	●	-	12	-	-	0,92	50
2270000500		3/4"	●	-	14	-	-	1,13	50
2270C00500		3/4"	●	-	14	-	-	1,20	50
2270000600		1"	●	-	16	-	-	1,75	50
2270C00600		1"	●	-	16	-	-	1,87	50

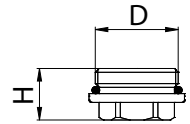

Tappo maschio con OR
per collettore
*Male plug with O-Ring
for manifold*
*Tapón macho con O-
Ring para colector*

231

Code	Version	Size (D)	Smooth	D1	H	I	L	€	Pack
2310000400		1/2"	●	-	15	-	-	1,09	50
2310C00400		1/2"	●	-	15	-	-	1,13	50
2310000500		3/4"	●	-	16	-	-	1,70	50
2310C00500		3/4"	●	-	16	-	-	1,81	50
2310000600		1"	●	-	20	-	-	2,57	50
2310C00600		1"	●	-	20	-	-	2,66	50



Riduzione MF con OR per collettore
Male-female reducer with O-Ring for manifold
Reducción MH con O-Ring para colector

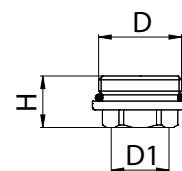

231B

Code	Version	Size (D)	Smooth	D1	H	I	L	€	Pack
231B050301		3/4"	●	3/8"	19	-	-	1,83	50
231BC50301		3/4"	●	3/8"	19	-	-	1,88	50
231B050401		3/4"	●	1/2"	20	-	-	1,68	50
231BC50401		3/4"	●	1/2"	20	-	-	1,74	50
231B060301		1"	●	3/8"	20	-	-	2,44	50
231BC60301		1"	●	3/8"	20	-	-	2,53	50
231B060401		1"	●	1/2"	20	-	-	2,56	50
231BC60401		1"	●	1/2"	20	-	-	2,68	50
231B060501		1"	●	3/4"	20	-	-	2,68	50
231BC60501		1"	●	3/4"	20	-	-	2,71	50



Niplo con OR
Nipple with OR
Nipple con junta OR

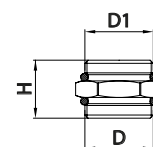

731

Code	Version	Size (D)	Smooth	D1	H	I	L	€	Pack
7310C00600		1"	●	1"	28	-	-	4,02	25



Niplo con OR preguarnito con ghiera
Nipple with immediate sealing and OR
Nipple con junta OR y tuerca

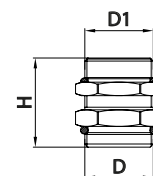

732

Code	Version	Size (D)	Smooth	D1	H	I	L	€	Pack
7320C00600		1"	●	1"	43	-	-	6,30	25



Niplo maschio-maschio Eurocono
Nipple MM Euroconus
Nipple macho-macho Eurocono

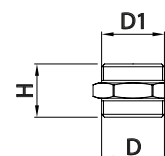

733

Code	Version	Size (D)	Smooth	D1	H	I	L	€	Pack
7330N00500		3/4"	●	3/4"	32	-	-	2,30	25

Terminali per collettori | Terminal parts for manifolds

Temperatura massima d'esercizio / Max working temperature: 80°C

Pressione massima d'esercizio / Max working pressure: 10 bar

Filetti / Threads: ISO 228

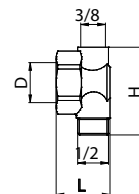

Tappo collettore con derivazione attacco maschio e scarico

Plug for manifold with male connection and discharge
Tapón para colector con derivación empalme macho y desagüe

228

Code	Version	Size (D)	Smooth	D1	H	I	L	€	Pack
2280000500		3/4"	●	-	57	-	35	4,48	15
2280C00500		3/4"	●	-	57	-	35	4,70	15
2280000600		1"	●	-	57	-	35	4,20	15
2280C00600		1"	●	-	57	-	35	4,46	15

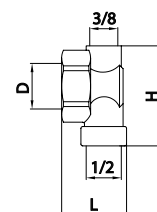

Tappo collettore con derivazione attacco femmina e scarico

Plug for manifold with female connection and discharge
Tapón para colector con derivación empalme hembra y desagüe

228B

Code	Version	Size (D)	Smooth	D1	H	I	L	€	Pack
228B000600		1"	●	-	57	-	35	4,20	15
228BC00600		1"	●	-	57	-	35	4,46	15

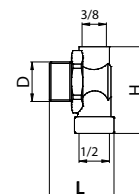

Tappo collettore preguarnito con derivazione attacco femmina e scarico

Plug for manifold with teflon ring, female connection and discharge
Tapón para colector con guarnición de teflon y con derivación empalme hembra y desagüe

229

Code	Version	Size (D)	Smooth	D1	H	I	L	€	Pack
2290000500		3/4"	●	-	57	-	40	4,43	15
2290C00500		3/4"	●	-	57	-	40	4,71	15
2290000600		1"	●	-	57	-	42	4,66	15
2290C00600		1"	●	-	57	-	42	4,86	15
2290000700		1 1/4"	●	-	57	-	48	10,61	15
2290C00700		1 1/4"	●	-	57	-	48	10,97	15



Terminale per collettore con valvola sfogo aria automatica e rubinetto di scarico

Terminal parts for manifold with automatic air discharge valve and drain ball valve

Tapón terminal con purgador automatico y válvula de descarga/escape

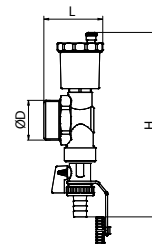

298

Code	Version	Size (D)	Smooth	D1	H	I	L	€	Pack
2980000500		3/4"	●	-	150	-	48	19,58	5
2980000600		1"	●	-	150	-	48	19,58	5
2980N00600		1"	●	-	150	-	48	20,58	5
2980000700		1 1/4"	●	-	150	-	48	25,67	5
2980N00700		1 1/4"	●	-	150	-	48	26,96	5



Terminale per collettore con valvola sfogo aria manuale e rubinetto di scarico

Terminal parts for manifold with manual air discharge valve and drain ball valve

Tapón terminal con purgador y válvula de descarga/escape

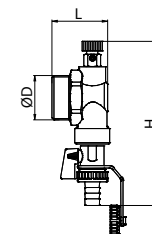

299

Code	Version	Size (D)	Smooth	D1	H	I	L	€	Pack
2990000500		3/4"	●	-	120	-	42	14,80	5
2990000600		1"	●	-	120	-	42	14,80	5
2990N00600		1"	●	-	120	-	42	15,36	5
2990000700		1 1/4"	●	-	120	-	42	21,53	5
2990N00700		1 1/4"	●	-	120	-	42	22,40	5

Accessori e ricambi | Accessories and spare parts



Flussimetro per collettori premontati
Flowmeter for pre-assembled manifold
 Caudalímetro para colector premontado

281

Code	Version	Size (D)	Smooth	D1	H	I	L	€	Pack
28100332M0		1/2"	●	-	-	-	-	11,74	1

Temperatura massima d'esercizio / Max working temperature: 70°C
 Pressione massima d'esercizio / Max working pressure: 6 bar
 Precisione di lettura / Accuracy of reading: +/- 10%



Raccordo Eurocono per flussimetro per collettori premontati
Euroconus fitting for flowmeter for pre-assembled manifold
 Racor Eurocono para caudalímetro para colector premontado

282

Code	Version	Size (D)	Smooth	D1	H	I	L	€	Pack
28200332M6		1/2"	●	3/4"	-	-	-	3,01	1

Per collettore da 1" in ottone / For 1" brass manifold

28200332M7		1/2"	●	3/4"	-	-	-	4,46	1
------------	--	------	---	------	---	---	---	-------------	---

Per collettore da 1 1/4" in ottone / For 1 1/4" brass manifold

28200332MA		1/2"	●	3/4"	-	-	-	3,28	1
------------	--	------	---	------	---	---	---	-------------	---

Per collettore da 1" in acciaio inox / For 1" stainless steel manifold



Vitone termostatico per collettore premontato
Screw valve for pre-assembled manifold
 Valvula de regulación para colector premontado

283

Code	Version	Size (D)	Smooth	D1	H	I	L	€	Pack
28300332T0		1/2"	●	-	-	-	-	4,94	1



Detentore per collettore premontato
Lockshield valve for pre-assembled manifold
 Detentor para colector premontado

284

Code	Version	Size (D)	Smooth	D1	H	I	L	€	Pack
28400332D0		1/2"	●	-	-	-	-	4,14	1
28400332DA		1/2"	●	-	-	-	-	4,24	1



Raccordo Eurocono vitone termostatico / detentore per collettore premontato
Euroconus fitting for screw valve / lockshield for pre-assembled manifolds
 Racor Eurocono para valvula de regulación / detentor para colector premontado

285

Code	Version	Size (D)	Smooth	D1	H	I	L	€	Pack
28500332T6		1/2"	●	3/4"	-	-	-	3,01	1

Per collettore da 1" in ottone / For 1" brass manifold

28500332T7		1/2"	●	3/4"	-	-	-	4,67	1
------------	--	------	---	------	---	---	---	-------------	---

Per collettore da 1 1/4" in ottone / For 1 1/4" brass manifold

28500332TA		1/2"	●	3/4"	-	-	-	3,28	1
------------	--	------	---	------	---	---	---	-------------	---

Per collettore da 1" in acciaio inox / For 1" stainless steel manifold



Vitone per collettore serie 232E-240E
Screw valve for 232E-240E series manifold
Valvula de regulaci3n para colector serie 232E-240E

286

Code	Version	Size (D)	Smooth	D1	H	I	L	€	Pack
28600232E6		3/8"	●	-	-	-	-	3,28	1



Raccordo Eurocono per collettori lineari estrusi serie 232E-240E
Euroconus fitting for 232E-240E series manifold
Racor Eurocono para colector serie 232E-240E

287

Code	Version	Size (D)	Smooth	D1	H	I	L	€	Pack
28700232E0		3/8"	●	3/4"	-	-	-	1,77	1



Raccordo Eurocono per collettori lineari estrusi serie 242E-250E / 242EA-250EA
Euroconus fitting for 242E-250E / 242EA-252EA series manifold
Racor Eurocono para colector serie 242E-250E / 242EA-252EA

288

Code	Version	Size (D)	Smooth	D1	H	I	L	€	Pack
28800242E0		1/2"	●	3/4"	-	-	-	1,80	50
2880N242E0		1/2"	●	3/4"	-	-	-	1,84	50

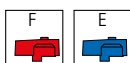

Levetta in alluminio per collettore con valvola a sfera
Aluminum handle for ball valve manifold
Manija en aluminio para colector con valvula de esferica

387

Code	Version	Size (D)	Smooth	D1	H	I	L	€	Pack
387000000E		-	-	-	-	-	-	1,28	1
387000000F		-	-	-	-	-	-	1,28	1

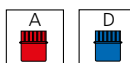

Volantino per collettore serie 232E - 240E
Handle for 232E - 240E manifold series
Volante para colector serie 232E - 240E

392/4

Code	Version	Size (D)	Smooth	D1	H	I	L	€	Pack
392000004A		-	-	-	-	-	-	0,68	1
392000004D		-	-	-	-	-	-	0,68	1



Volantino per collettore con valvola inclinata
Handle for manifold with oblique valve
Volante para colector con valvula inclinada

392/5

Code	Version	Size (D)	Smooth	D1	H	I	L	€	Pack
392000005A		-	-	-	-	-	-	0,62	1
392000005D		-	-	-	-	-	-	0,62	1

Schema raccordi meccanici per collettori | Compression fittings for manifolds

Tutti i raccordi per collettori sono del tipo a tenuta meccanica mediante compressione di un'ogiva (metallica o morbida) conseguente all'avvitamento del dado stringitubo. Nell'accoppiamento tubo-raccordo-collettore, assicurarsi che l'asse della tubazione sia il naturale prolungamento dell'asse del raccordo; un inserimento non coassiale potrebbe pregiudicarne la buona tenuta.

I raccordi meccanici per collettori hanno le seguenti caratteristiche tecniche:

- corpo e dado in ottone CW617N
- ogive metalliche in ottone CW614N - CW508L
- ogive morbide in PTFE o EPDM
- anelli di tenuta O-Ring in EPDM
- temperatura max. di esercizio 100 °C
- pressione max di esercizio 10 bar

All the fittings for the manifolds are the mechanical seal type by means of compression of an olive (metal or soft) following screwing down of the pipe clamp nut. In the coupling of the pipe-fitting-manifold, ensure the axes are coincident otherwise the sealing will be compromised.

The mechanical fittings for manifolds have the following technical characteristics:

- brass body and nut CW617N
- brass olives CW614N - CW508L
- soft PTFE or EPDM olives
- EPDM O-Rings
- max. operating temperature 100 °C
- max. operating pressure 10 bar

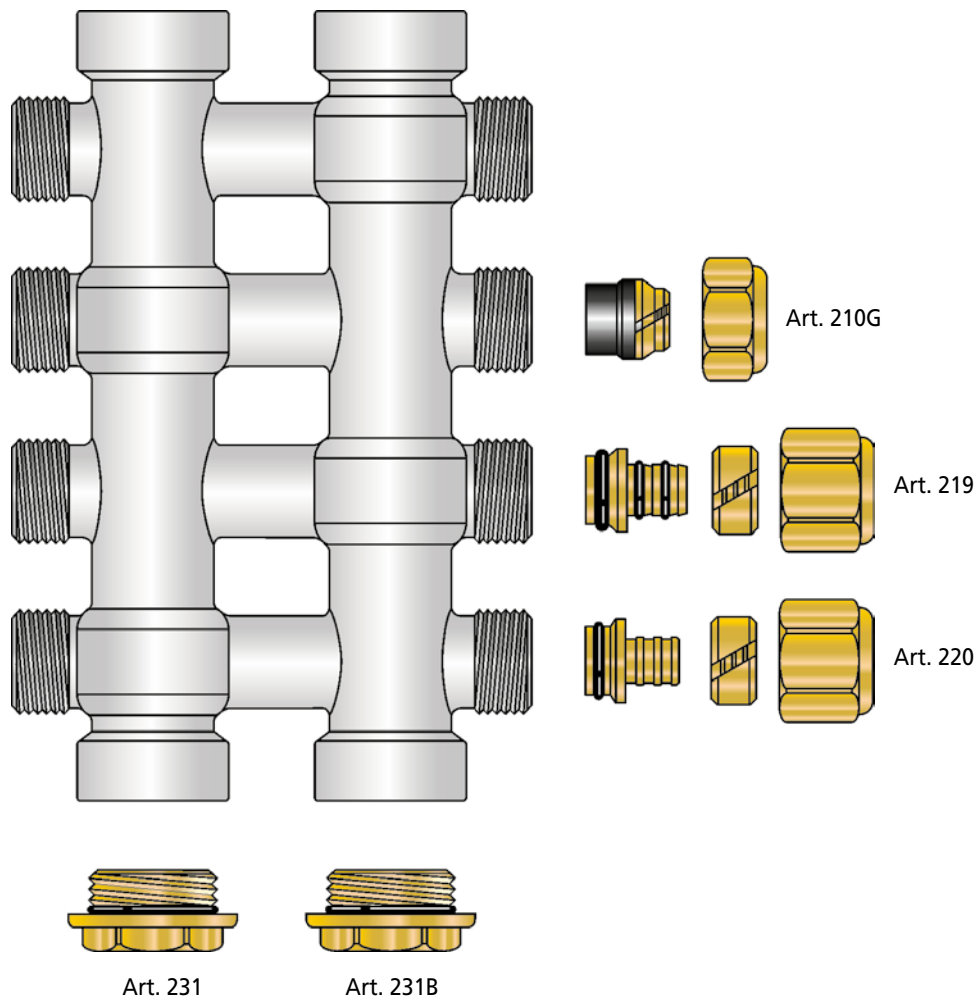
Raccordi per collettori complanari / Fittings for double pattern manifolds

Raccordi per collettori lineari stampati / Fittings for linear forged manifolds

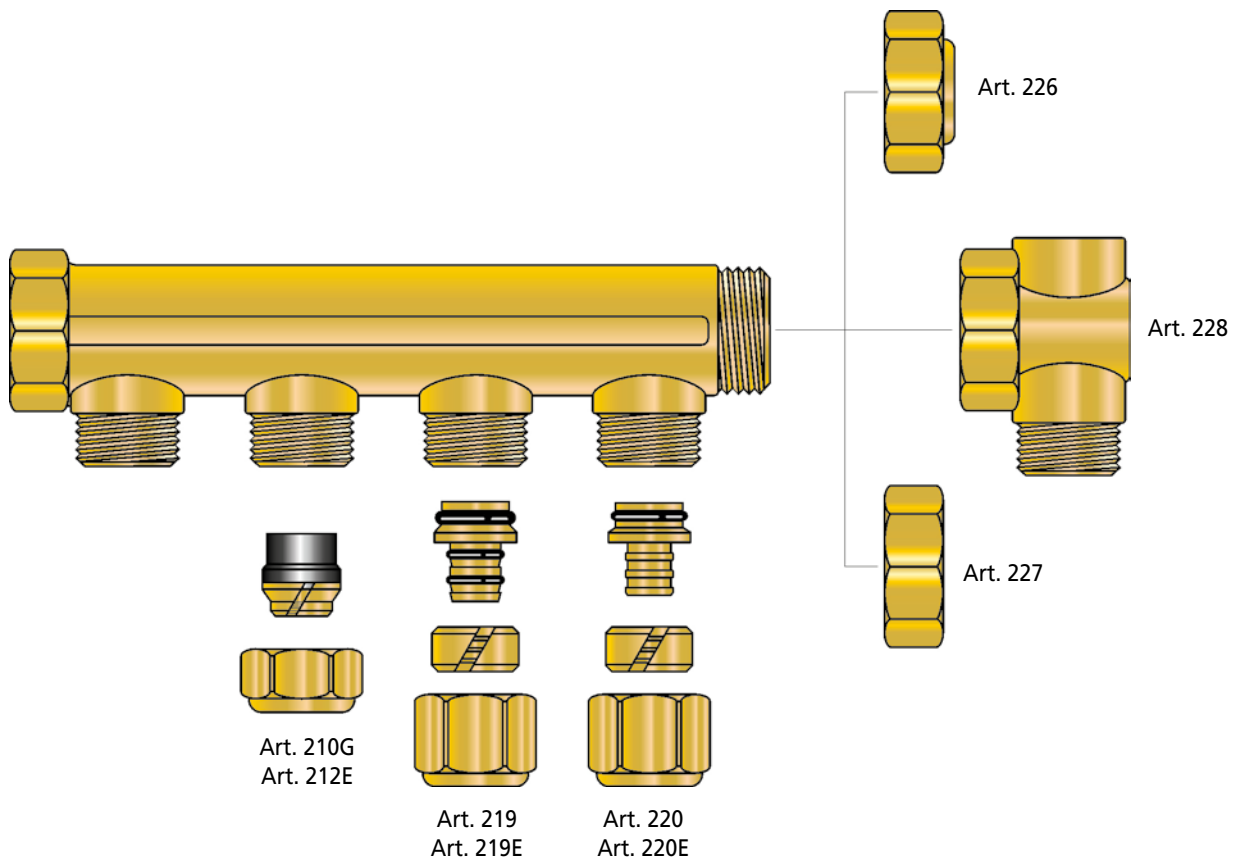

Raccordi per collettori lineari estrusi / Fittings for linear extruded manifolds

